

## LIMITS TO ACCELERATORS

FOR CIRCULAR MACHINES

PROTONS  $\rightarrow$  B FIELD & RADIUS  $\rho = \frac{p}{0.3B}$

LHC 8.4T SUPERCONDUCTING MAGNETS



CLOSE TO LIMIT FOR  
 $Nb_3Sn$  SUPERCONDUCTOR

$R_{EFF} = 3km$

CIRC = 27km

THERE ARE HIGHER FIELD MAGNETS UNDER  
DEVELOPMENT  $\rightarrow$  MECHANICAL STRESS?

ELECTRONS  $\rightarrow$  LEP WAS AT SYNCHROTRON

RADIATION LIMIT

SO WE SEEM CLOSE TO LIMIT FOR CONVENTIONAL  
CIRCULAR MACHINES.

# LIVINGSTON PLOT

PROTONS

ELECTRONS

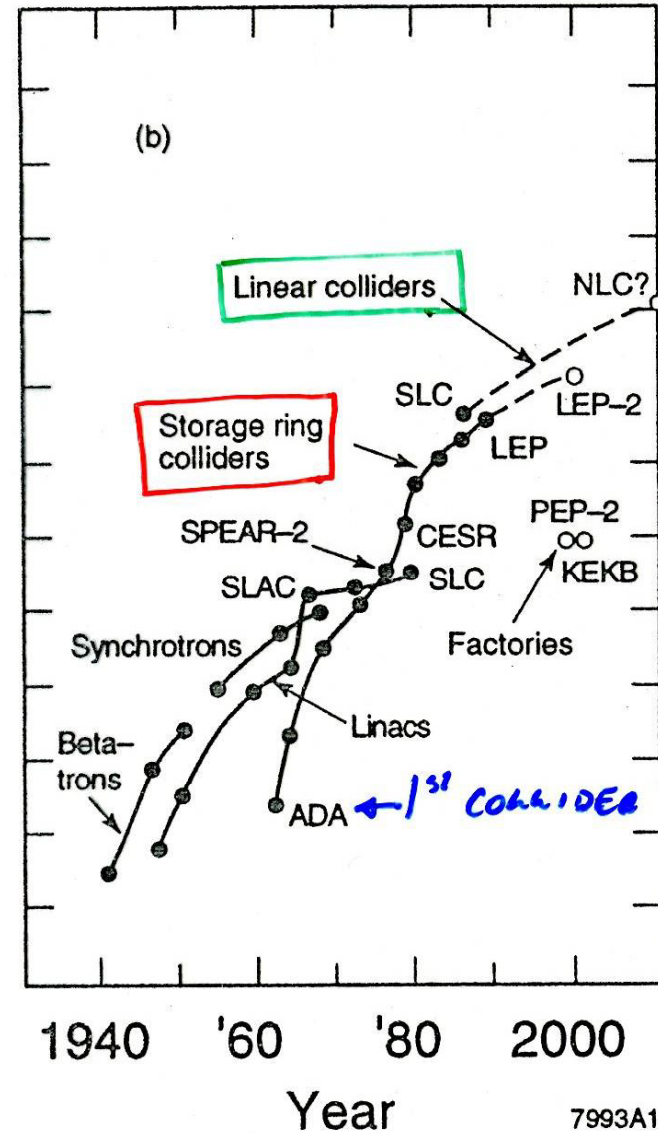
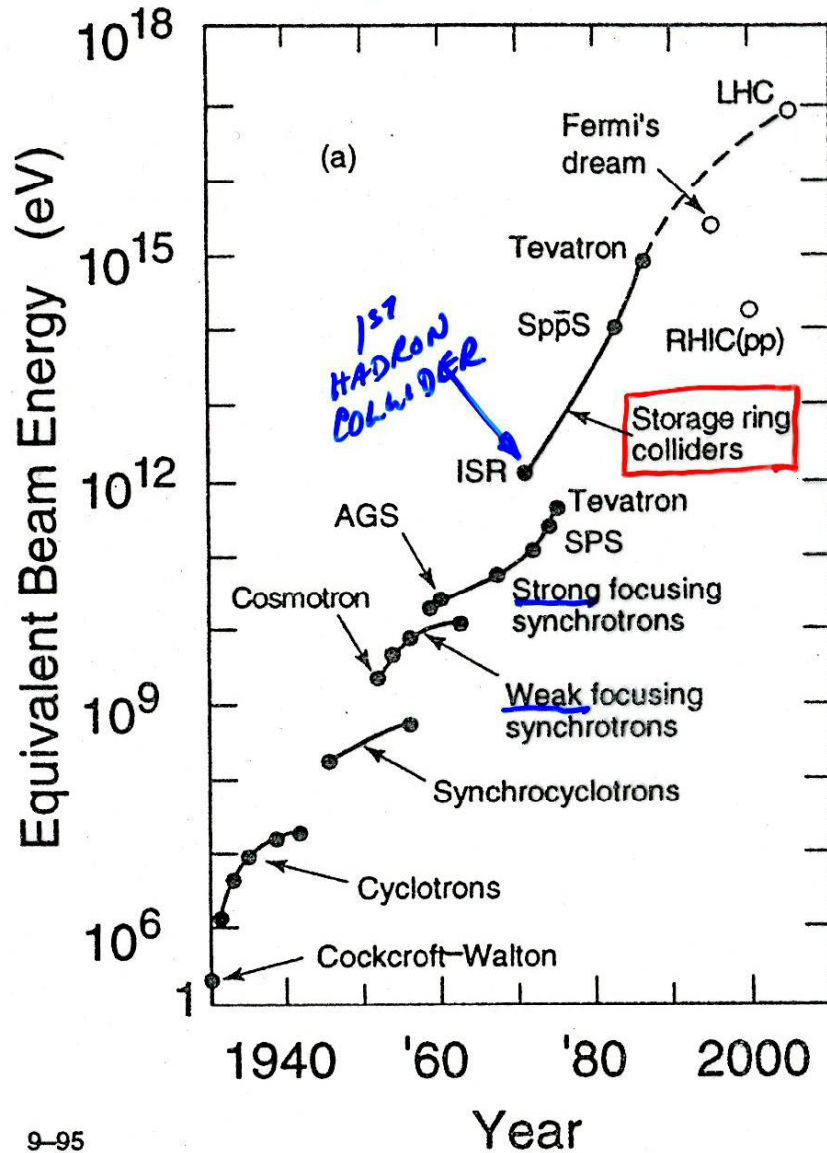

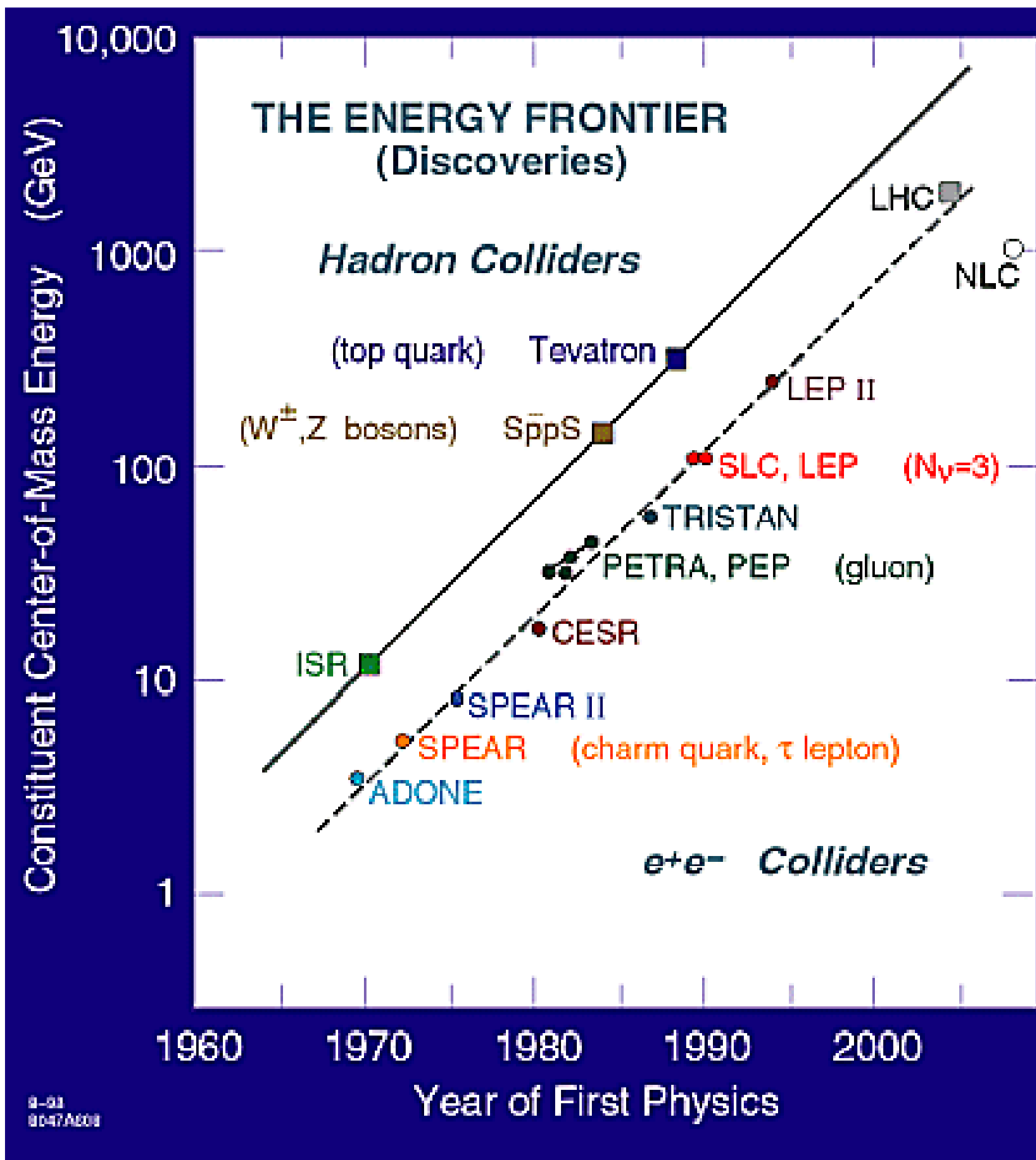

# LHC Prospects

Already time to think of upgrading the machine

Two options presently discussed/studied

- Higher luminosity  $\sim 10^{35} \text{cm}^{-2} \text{s}^{-1}$  (SLHC)
  - Needs changes in machine and particularly in the detectors
    - ⇒ Start change to SLHC mode some time 2012-2014
    - ⇒ Collect  $\sim 3000 \text{fb}^{-1}$ /experiment in 3-4 years data taking.
- Higher energy?
  - LHC can reach  $\sqrt{s} = 15 \text{ TeV}$  with present magnets (9T field)
  - $\sqrt{s}$  of 28 (25) TeV needs  $\sim 17$  (15) T magnets  $\Rightarrow$  R&D + MCHf needed

# Machine Upgrade in Stages

- Push LHC performance *without* new hardware
  - luminosity  $\rightarrow 2.3 \times 10^{34} \text{ cm}^{-2}\text{s}^{-1}$ ,  $E_b = 7 \rightarrow 7.54 \text{ TeV}$
- LHC IR upgrade
  - replace low- $\beta$  quadrupoles after  $\sim 7$  years
  - peak luminosity  $\rightarrow 4.6 \times 10^{34} \text{ cm}^{-2}\text{s}^{-1}$
- LHC injector upgrade
  - peak luminosity  $\rightarrow 9.2 \times 10^{34} \text{ cm}^{-2}\text{s}^{-1}$
- LHC energy upgrade
  - $E_b \rightarrow 13 - 21 \text{ TeV}$  (15  $\rightarrow$  24 T dipole magnets)

# Beam-Beam Limit Luminosity Equation

injector upgrade

$$L \approx \pi \gamma n_b \frac{(\gamma \epsilon) f_{rev}}{r_p^2 \beta^*} \Delta Q_{bb}^2 \sqrt{1 + \phi^2} F_{profile}$$

LHC + injector changes

IR upgrade

LHC+ injector changes

# Summary of Luminosity Upgrade

Scenarios for  $L \sim 10^{35} \text{ cm}^{-2} \text{ s}^{-1}$  with acceptable heat load and events/crossing

25-ns: push  $\beta^*$  to limit

- Slim magnets inside detector
- Crab Cavities
- High Gradient, Large Aperture  $Nb_3Sn$  Quads

50-ns: Fewer bunches, higher charge

- Realizable with  $NbTi$
- Beam-Beam tune shift due to large Piwinski angle?
- Luminosity leveling via bunch length and  $\beta^*$  tuning

# Indicative Physics Reach

Ellis, Gianotti, ADR

hep-ex/0112004+ updates

Units are TeV (except  $W_L W_L$  reach)

□ Ldt correspond to 1 year of running at nominal luminosity for 1 experiment

PROCESS	LHC 14TeV 100 fb <sup>-1</sup>	SLHC 14TeV 1000 fb <sup>-1</sup>	SLHC 28TeV 100 fb <sup>-1</sup>	LinCol 0.8 TeV 500 fb <sup>-1</sup>	LinCol 5 TeV 100 fb <sup>-1</sup>
Squarks	2.5	3	4	0.4	2.5
$W_L W_L$	2 $\sigma$	4 $\sigma$	4.5 $\sigma$		
Z'	5	6	8	8 <sup>†</sup>	8 <sup>†</sup>
Extra Dim ( $\delta=2$ )	9	12	15	5 - 8.5 <sup>†</sup>	30 - 55 <sup>†</sup>
q*	6.5	7.5	9.5	0.8	5
$\Lambda_{\text{comp}}$	30	40	40	100	400
TGC ( $\lambda_\gamma$ )	0.0014	0.0006	0.0008	0.0004	0.00008

Approximate mass reach machines:

† indirect reach

(from precision measurements)

$\sqrt{s} = 14 \text{ TeV}, L=10^{34}$  (LHC) : up to  $\approx 6.5 \text{ TeV}$

$\sqrt{s} = 14 \text{ TeV}, L=10^{35}$  (SLHC) : up to  $\approx 8 \text{ TeV}$

$\sqrt{s} = 28 \text{ TeV}, L=10^{34}$  : up to  $\approx 10 \text{ TeV}$



OUR PRECISION CHECK OF STANDARD MODEL  
COUPLINGS WAS DONE AT LEP  $e^+e^-$

IF WE DISCOVER HIGGS WE WILL HAVE TO  
CHECK COUPLINGS AT AN  $e^+e^-$  MACHINE

GIVEN THE ENERGY AND LUMINOSITY  
REQUIRED

CIRCULAR MACHINE IMPRACTICAL  
DUE TO SYNCHROTRON RADIATION

LINEAR COLLIDER  $\rightarrow$  NO SYNCHROTRON RADIATION

LENGTH & COST OF LINEAR COLLIDER  
DETERMINED BY ACCELERATING VOLTAGE

## Q VALUE & ACCELERATING VOLTAGE

AT RESONANT FREQUENCY OF CAVITIES

$$Q = \frac{\omega_r}{\Delta\omega} = \frac{R_s}{Z}$$

← SHUNT IMPEDENCE  
← GEOMETRY FACTOR

ALL RF POWER IS CONVERTED TO HEAT IN  $R_s$

$$P_{RF} = \frac{1}{2} I_0 V_0 = V_0^2 / 2R_s$$

$$V_0 = \sqrt{2R_s P_{RF}}$$

NEED HIGH RF POWER FOR  $V_0$  HIGH

$$R_s = QZ$$

$$V_0 = \sqrt{2ZQ P_{RF}}$$

NEED HIGH Q VALUE

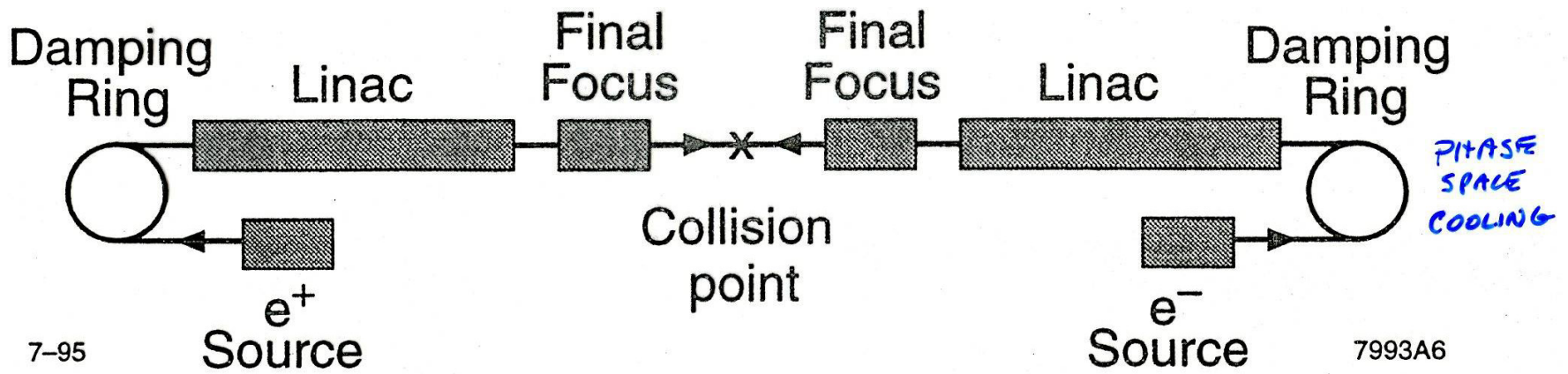

Fig. 4. Schematic layout of a linear collider design.

$$\text{CAVITY POWER} = V_0 / \sqrt{2R_s} = P$$

$$V_0 = \sqrt{2R_s P_{RF}}$$

EG SLAC

FOR SLAC  $V_0 \text{ [MeV]} = 27.5 \sqrt{P \text{ [MWATT]}}$

POWER PRACTICALITIES LIMIT  $V_0$

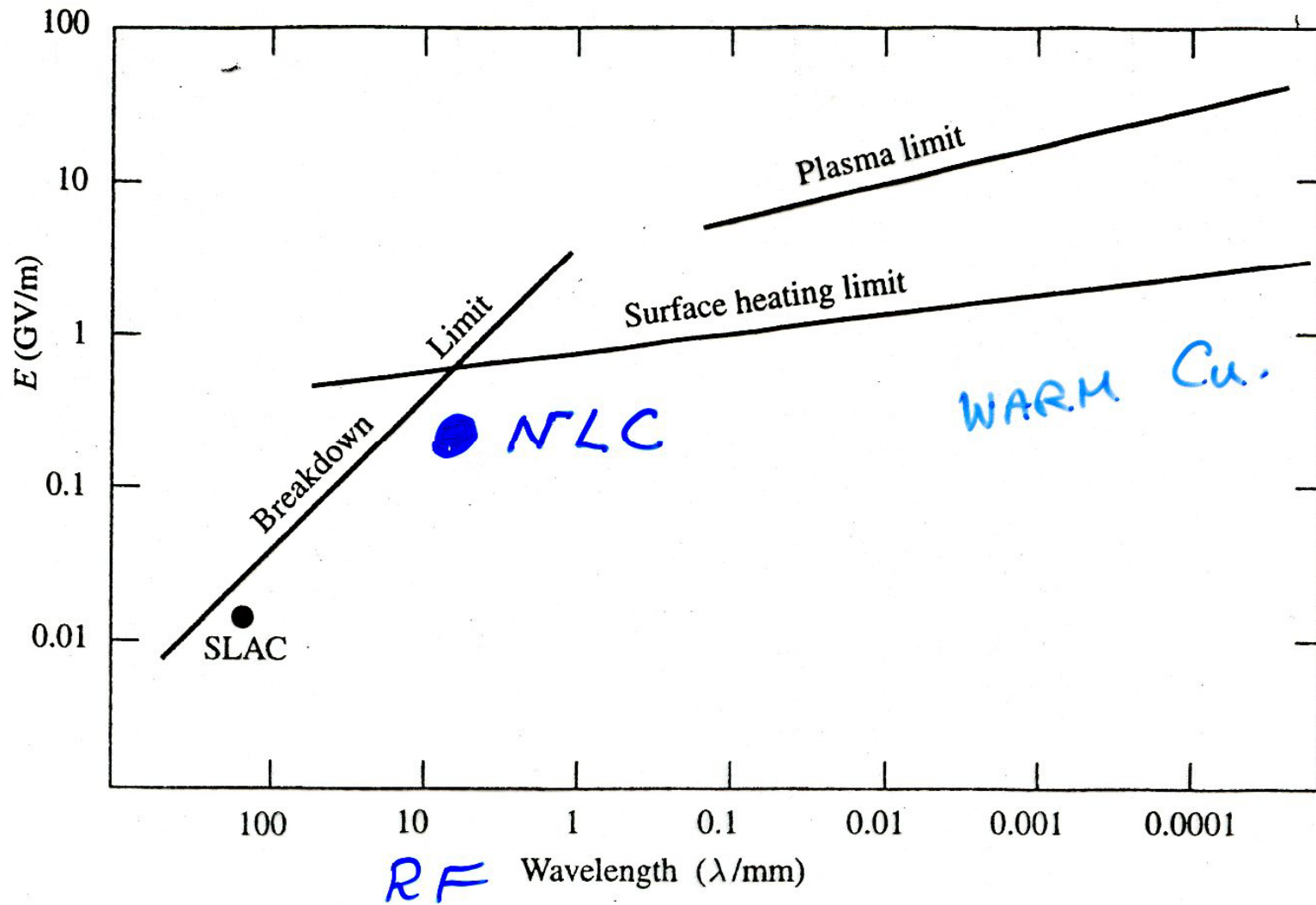

Fig. 11.5 Maximum allowable fields on a copper surface.

PHYSICS  $\sigma \sim 1/E_{cm}^2$

MACHINE  $\mathcal{L} \sim N^2 f/A$  ← BEAM CROSS SECTION

$P \sim E_{cm} \cdot N \cdot f$

EVENT RATE =  $\mathcal{L} \cdot \sigma \rightarrow$  WANT CONSTANT WITH  $E_{cm}$

WANT  $\mathcal{L} \sim E_{cm}^2$

BUT  $\mathcal{L} \sim \frac{NP}{E_{cm} \cdot A}$   $\left( f \sim \frac{P}{E_{cm} N} \right)$

$E_{cm}^2 \sim \frac{NP}{E_{cm} \cdot A}$   $A \sim \frac{NP}{E_{cm}^3}$

$A \sim \frac{1}{E_{cm}^3}$  ← TINY BEAM CROSS SECTIONAL AREA

# LINEAR COLLIDER - BEAM-BEAM TUNE SHIFT?

TINY, INTENSE BEAMS GIVE LARGE  $\Delta V$

BAD  $\rightarrow$  BEAMSTRALUNG

GOOD  $\rightarrow$  FOCUSING  $\rightarrow$  HIGH  $\mathcal{L}$

$$\Delta V = \frac{N_B \Gamma_0}{4\pi\gamma\sigma^2} = \frac{N_B \Gamma_0}{4\pi\epsilon_n}$$

$\nwarrow$  # OF PARTICLES IN OPPOSING BUNCH

$\nwarrow$  NORMALIZED EMITTANCE

$\nwarrow$  BEAM SIZE

$$D = \frac{\sigma_s}{f} = \frac{N \Gamma_0 \sigma_s}{\gamma \sigma^2}$$

DISRUPTION FACTOR  
 $\rightarrow$  RATIO OF BUNCH  
LENGTH TO FOCAL  
LENGTH

CAN BE  $\gg 1$  TO GIVE HIGH LUMINOSITY

BEAM-BEAM INTERACTION  $\rightarrow$   $f_{x, z}$   $f_z$   
FOCAL LENGTHS

DISRUPTION ANGLE  $\theta_0 = \frac{\sigma_x}{f_x} = \frac{\sigma_z}{f_z} = \frac{2Nr_0}{\gamma(\sigma_x + \sigma_z)}$

$$D_{x, z} = \frac{2Nr_0\sigma_s}{\gamma\sigma_{x, z}(\sigma_x + \sigma_z)} = \frac{\sigma_s}{f_{x, z}} = \frac{\Delta\gamma_{x, z}}{A_{x, z}}$$

$$A_{x, z} = \frac{\beta_{x, z}}{\sigma_s}$$

$$\mathcal{L} = \mathcal{L}_0 \times H_D(P_{x, z}, A_{x, z})$$

$\sim 2$  @ SLAC

COLLIDING BUNCHES EMIT SYNCHROTRON  
RADIATION  $\rightarrow$  BEAMSTRAHLUNG

BEAMSTRAHLUNG  
PARAMETER  $\mathcal{I} = \frac{2}{3} \frac{\hbar \omega_c}{E} = \frac{\hbar \gamma^2}{m c \rho} = \frac{2B}{B_c}$  ①

$B \rightarrow$  MAGNETIC FIELD OF COLLIDING BUNCHES

$$B_c \rightarrow = m^2 c^2 / e \hbar \approx 4.4 \times 10^9 \text{ T}$$

$$\hbar \omega_c \rightarrow \frac{3}{2} \hbar c \gamma^2 / \rho$$

① COMPARES  $E_{\text{BREMS}}$  to  $E_{\text{beam}}$

$$\langle \mathcal{I} \rangle \approx \frac{5}{12\pi} \frac{N_B \Gamma_0 \lambda_c \delta}{12\pi \sigma_s (\sigma_x + \sigma_z)}$$



$$\mathcal{L} = \mathcal{L}_0 \times H(D) (D_{x,z}, A_{x,z})$$

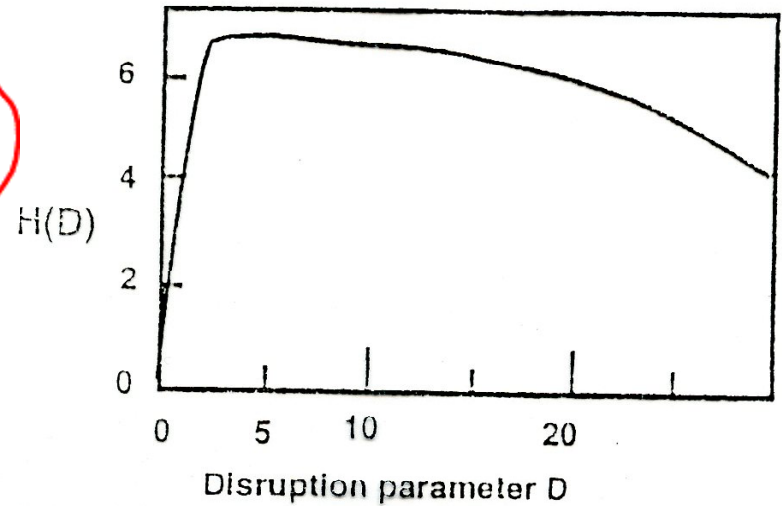

The deflection of the  $e^\pm$  due to the other bunch causes radiation known as beamstrahlung.

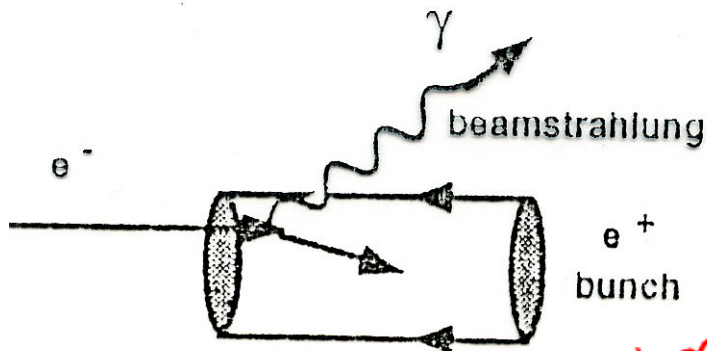

$$\langle \mathcal{I} \rangle \approx \frac{5}{12\pi} \frac{N_B \Gamma_0 \lambda_c \sigma}{12\pi \sigma_s (\sigma_x + \sigma_z)}$$

Table 5.2: Parameters of Linear Collider Design

	SLC	NLC/JLC	TESLA	CLIC	
$E_{\text{cm}}$ CM Energy[TeV]	0.1	1	0.8	1	5
Luminosity[ $10^{34}\text{cm}^{-2}\text{s}^{-1}$ ]	.0003	1.3	5.0	1.1	14.9
$N[10^{10}]$	4.2	0.75	1.41	0.4	0.4
$B$ per train	1	192	4500	150	150
Rep. Rate[Hz]	120	120	120	150	50
$\sigma_x^*$ [nm]	1400	235	392	123	27
$\sigma_z^*$ [nm]	700	3.9	2.0	2.7	0.45
$\sigma_s^*$ [ $\mu\text{m}$ ]	1100	120	300	50	25
$\gamma\epsilon_x[10^{-6}\text{m-rad}]$	55	3.6	8	1.48	0.58
$\gamma\epsilon_z[10^{-6}\text{m-rad}]$	10	0.04	0.01	0.07	0.01
$\mathcal{D}_x$ (disruption parameter)	0.91	0.12	0.2	0.07	0.16
$\mathcal{D}_z$ (disruption parameter)	1.81	7.2	39	3.40	9.3
$H_D$ (enhancement factor)	2.1	1.46	1.8	1.54	1.99
$\langle Y \rangle$ (beamstrahlung)	0.0016	0.29	0.085	0.57	27

**SLAC/LBL/LLNL  
SLAC-Based B Factory:  
PEP-II and BABAR**

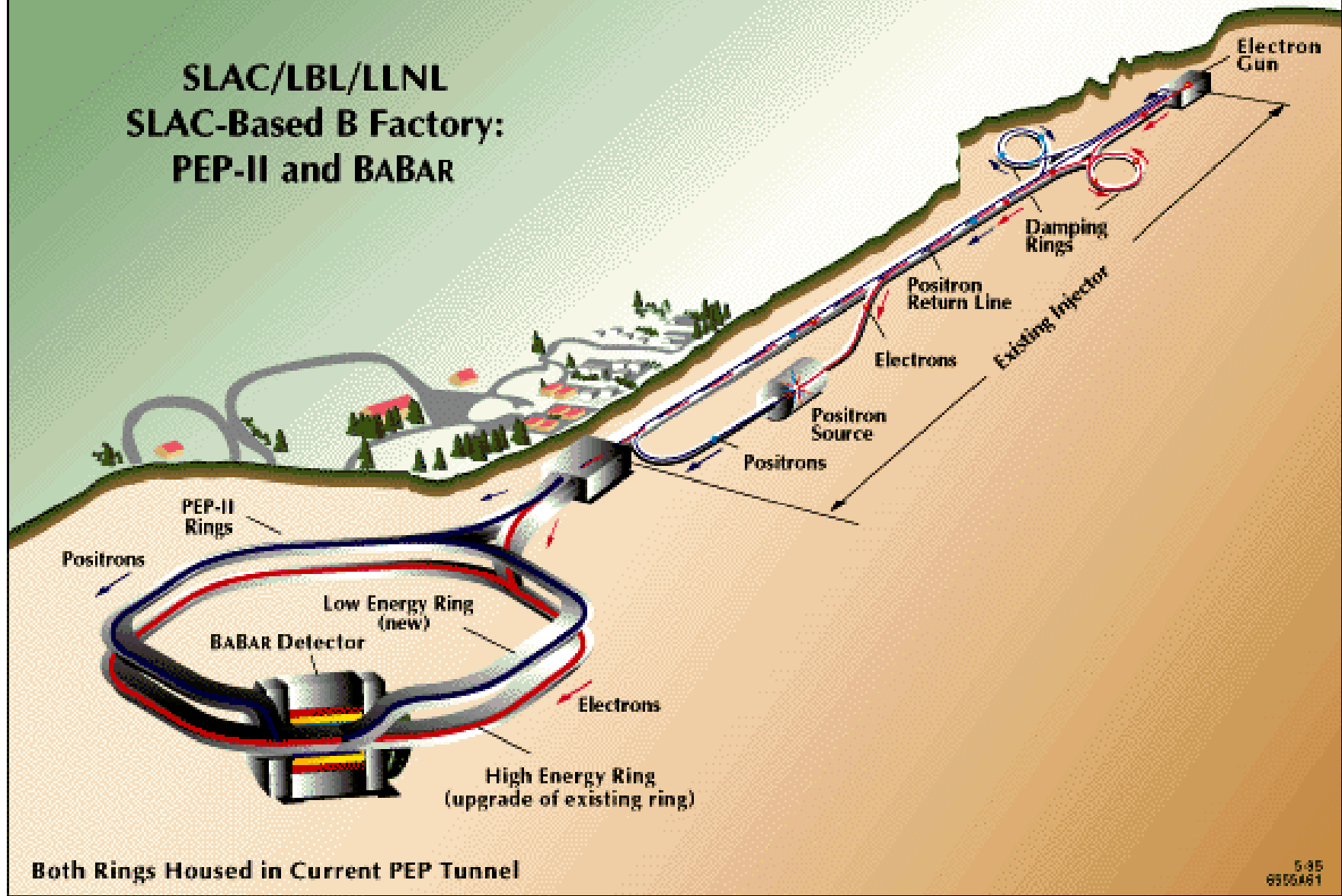

## SLC 100 GeV

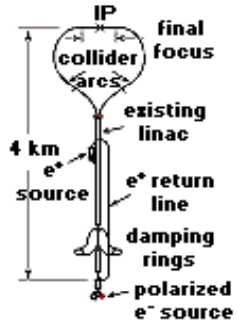

## NLC 0.5 - 1.5 TeV

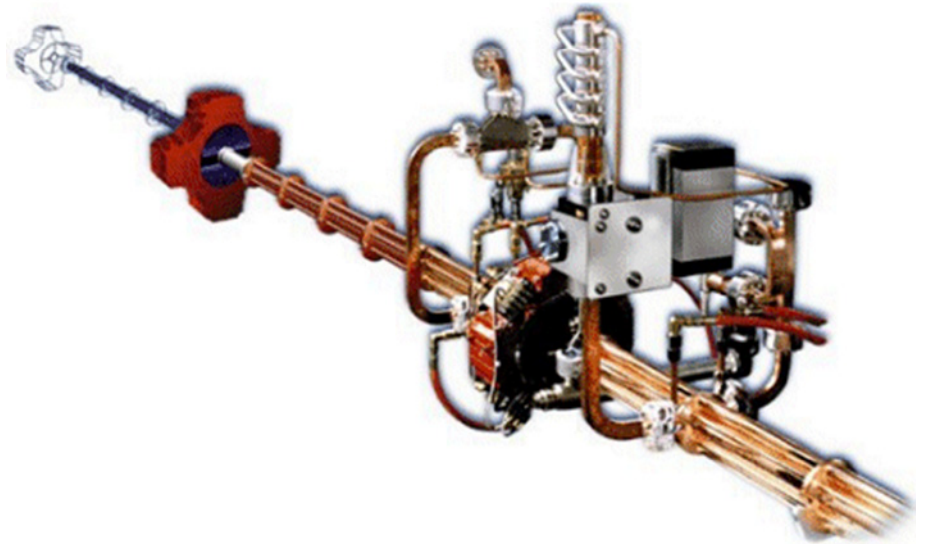
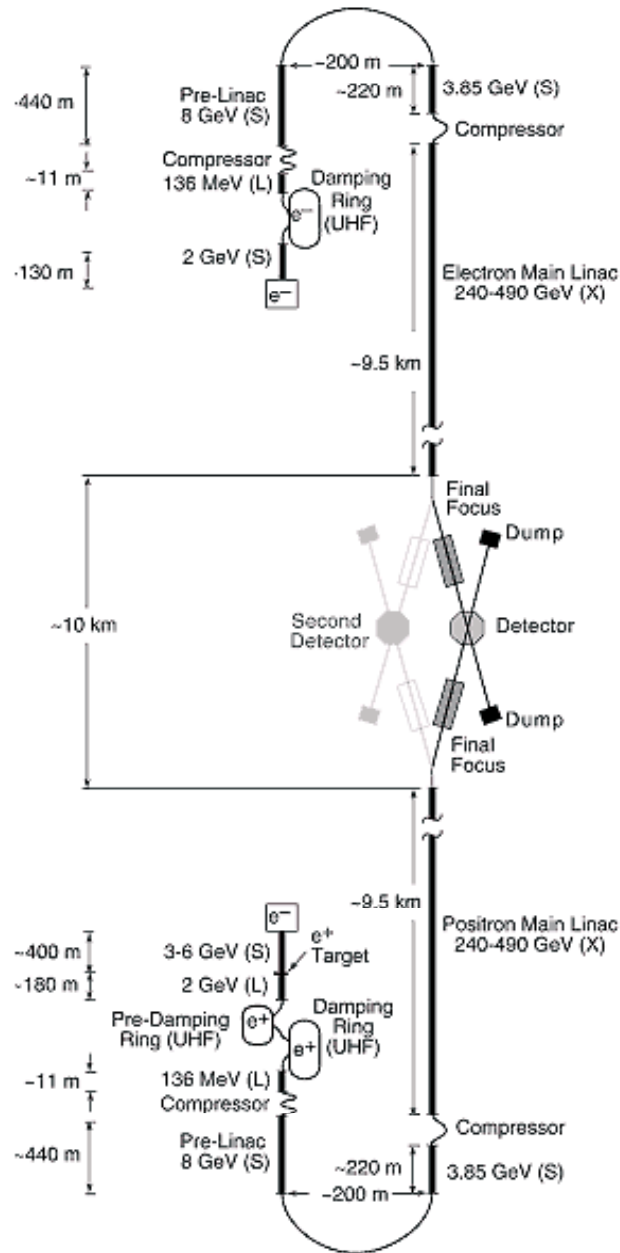

WARM COPPER CAVITY NLC

ABANDONED IN FAVOUR OF MACHINE

USING SUPERCONDUCTING RF ILC

— BREAKDOWN IN CU CAVITIES

⊙ HIGH FIELD

— SRF MATURE TECHNOLOGY

TESLA ⊙ DESY

FLASH ⊙ DESY

XFL ⊙ DESY

# A Primary Cost Driver for ILC -- Superconducting RF Technology

- 1.3 GHz technology developed by TESLA Collaboration, R&D from 1992 to reduce the cost per MeV by a factor of 20 from current SCRF installations (CEBAF).
- Increased the operating accelerating gradient by a factor of 5 :  
~5 MV/m to ~25 MV/m,  
Reduced the cost per meter by a factor of four for large-scale production.
- TESLA cavity R&D based on CERN, CEBAF (JLAB), Cornell University, KEK, Saclay and Wuppertal.
- Basic element of the technology is a nine-cell 1.3 GHz niobium cavity.
- Approximately 160 of these cavities have been fabricated by industry as part of R&D program at DESY.



# INTERNATIONAL LINEAR COLIDER

- ECM = 500GeV max within a site footprint of ~31km.
- Main Linacs: superconducting cavities
- Eacc = 31.5MV/m (16000 x 9-cell cavities → 2 x ~12km)
- Injectors: Polarized (P~80%) e- source
- 2 damping rings (e- and e+) around interaction region.

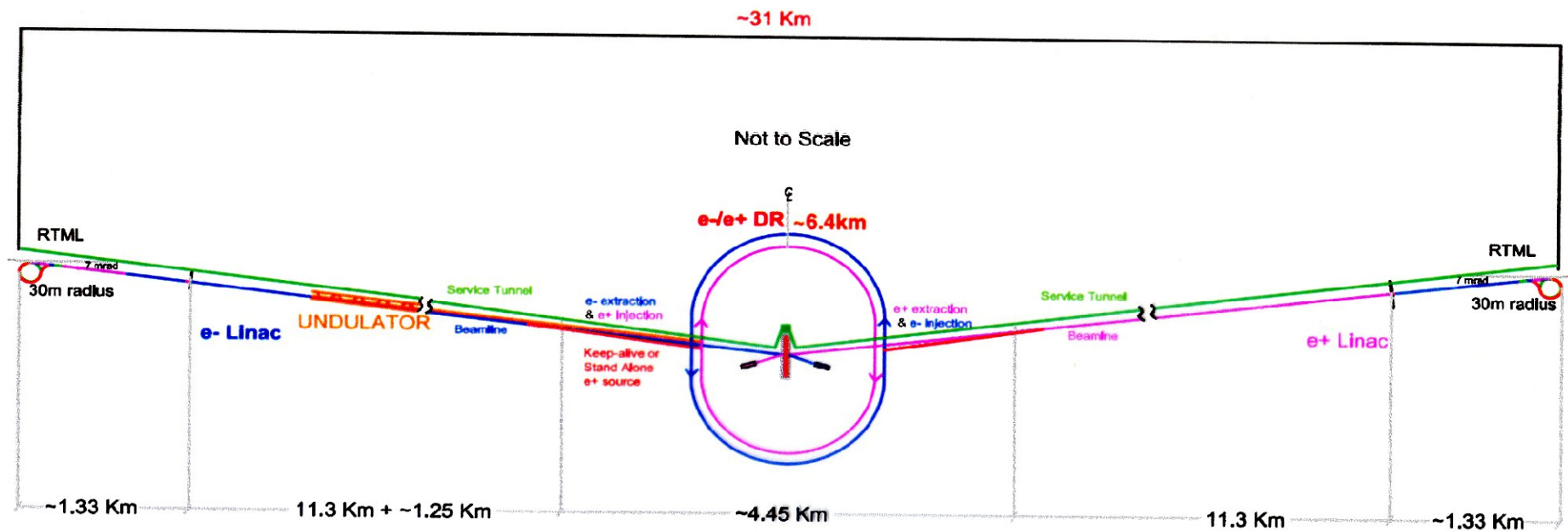

Schematic Layout of the 500 GeV Machine

# The base technology

The core technology for the ILC is 1.3GHz superconducting RF cavity intensely developed in the TESLA collaboration, which was recommended for the ILC by the ITRP on 2004 August. The cavities are installed in a long cryostat and cooled at 2k, and operated at gradient 31.5MV/m.

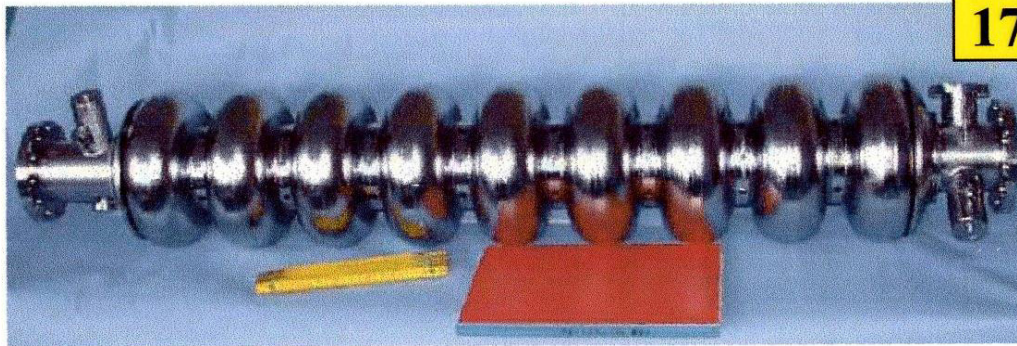

**17000 cavities**

~ 31 km long

**2100 modules**

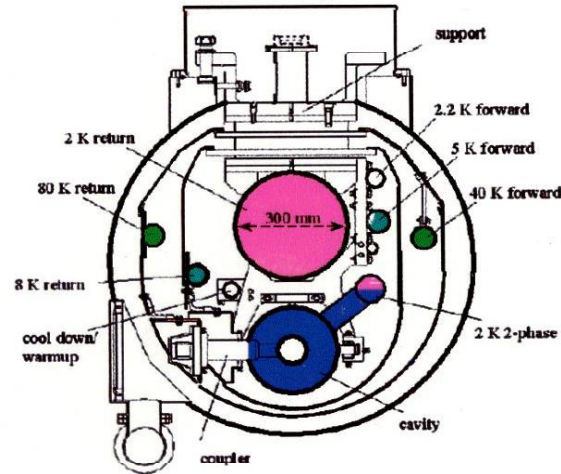
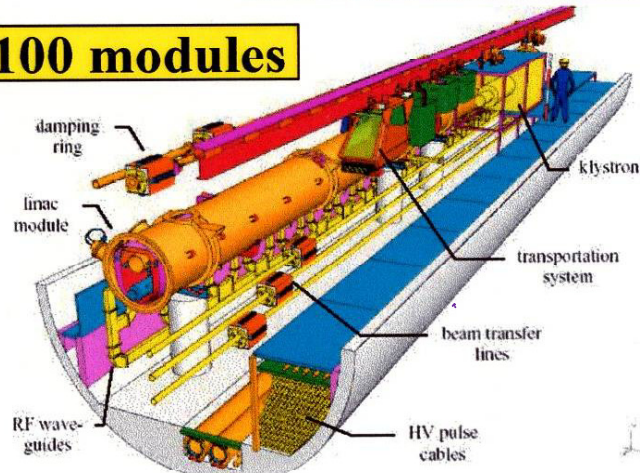

7/15/2006

EPAC06 June

Figure 3.3.2: Cross section of cryomodule.



# Why Aim for Higher Gradient ?

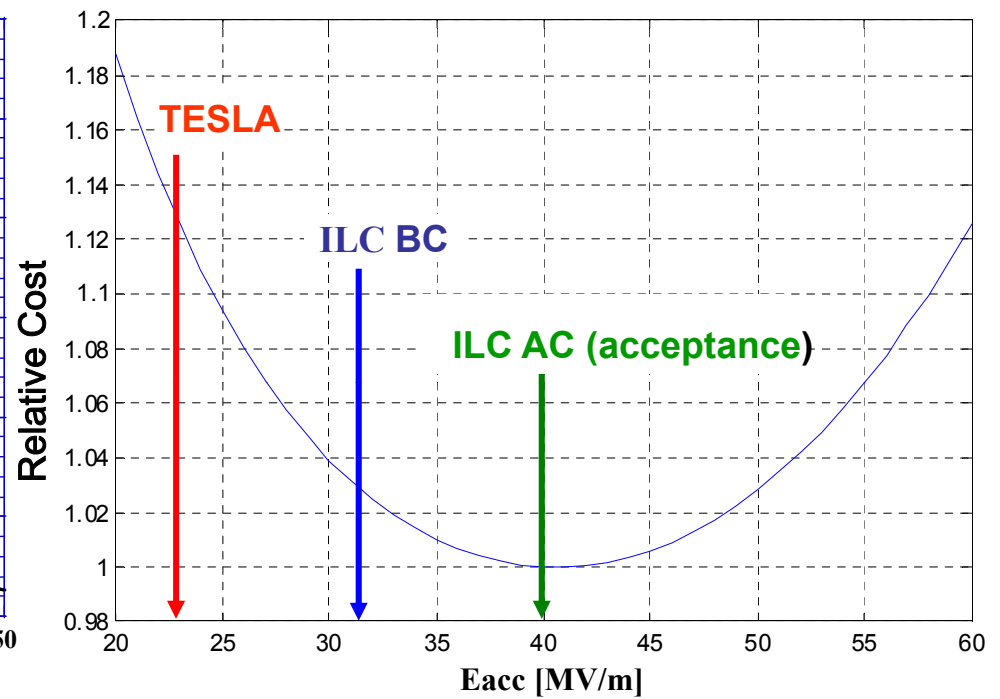
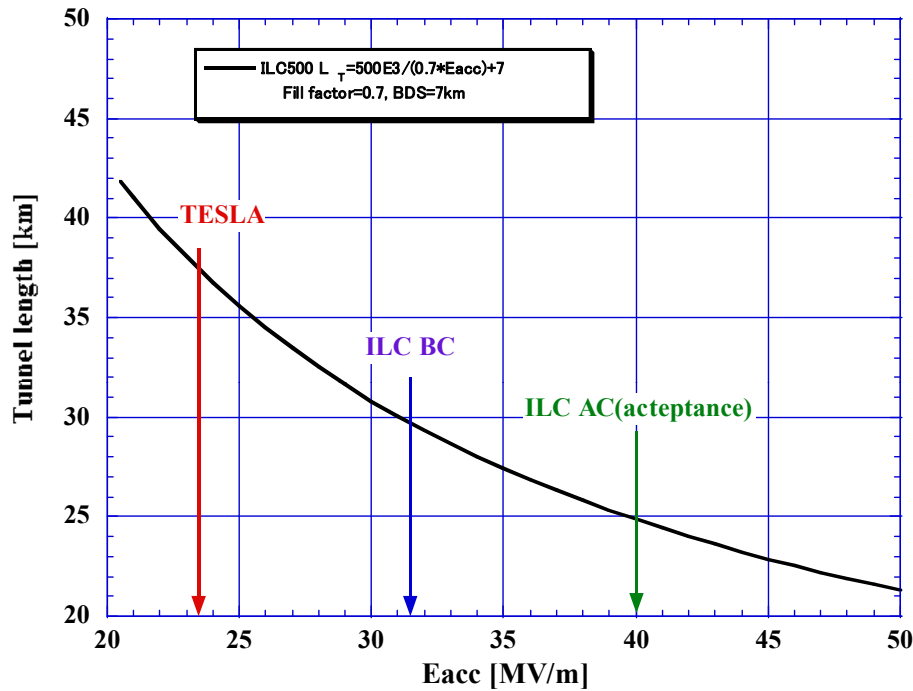

## ILC500 Gradient dependence with tunnel length and cost

$$\text{Total cost} = \text{Tunnel}(1/Eacc) + \text{Cryomodul}(1/Eacc) + \text{RF}(Eacc) + \text{Cryoplant}(Eacc^2) + \text{Cryo-Operation}(Eacc^2) + \text{Beampower}(\text{const})$$

$$= [C_T + C_{CM}] \cdot \frac{1}{Eacc} + C_{RF} \cdot Eacc + [C_{Cryplant} + C_{Cryoop}] \cdot Eacc^2 + C_{Beampower}$$

# ILC Main LINAC Cavity Baseline

ILC parameters related to SCRF		BCD: Baseline	ACD: Alternative
Cavity Shape		<b>TESLA</b>	<b>Low loss Reentrant</b>
<b>Acceptance Performance</b>	<b>Gradient [MV/m]</b>	<b>35</b>	<b>40</b>
	<b>Qo</b>	<b>0.80E10</b>	<b>0.80E10</b>
<b>Operation Performance</b>	<b>Gradient [MV/m]</b>	<b>31.5</b>	<b>36</b>
	<b>Qo</b>	<b>1.0E10</b>	<b>1.0E10</b>

## TWO BEAM ACCELERATION (TBA)

(4 CAS + 2 TRS)/module

Drive beam with 1856 bunches of 17.5 nC/bunch

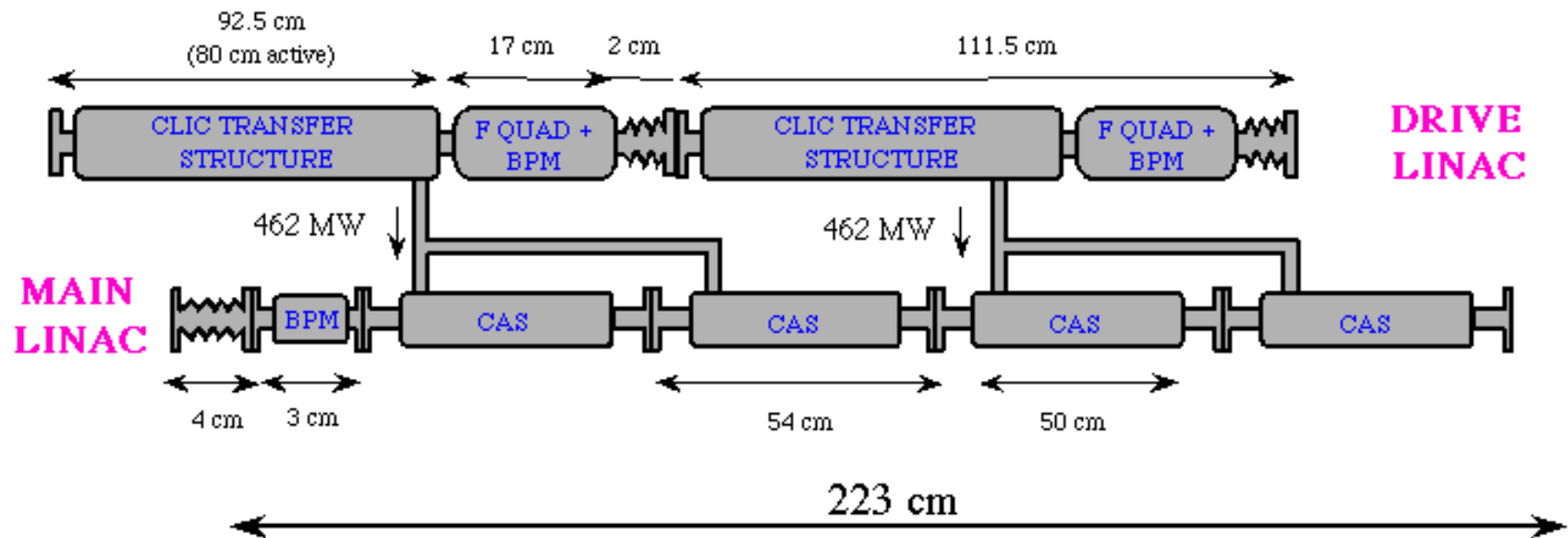

**CLIC module layout**

**3 TeV**

# CLIC 3 TeV

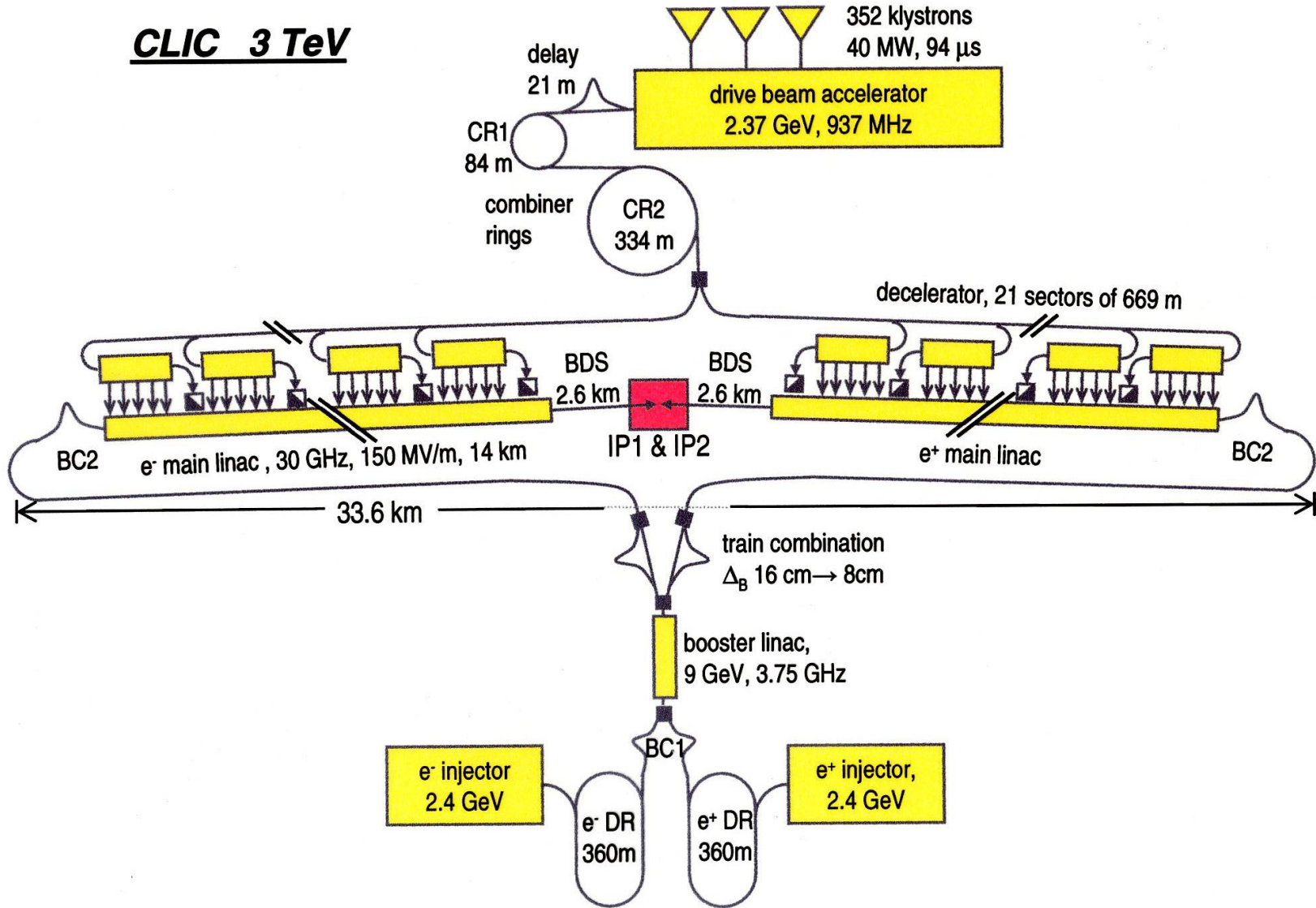

## ***Limitations of $E_{ACC}$***

### **Field emission due to surface electric field**

#### **Consequences:**

- Local plasma triggered by field emission  $\Leftrightarrow$  RF break down  $\Leftrightarrow$  Erosion of surface
- Break down rate  $\Rightarrow$  Operation efficiency
- Dark current capture
  - $\Rightarrow$  Efficiency reduction+activation+detector backgrounds+wakefields

### **Surface magnetic field**

Pulsed heating  $\Rightarrow$  material fatigue  $\Rightarrow$  cracks

### **Dark energy**

RF power flow and/or iris aperture apparently have a strong impact on achievable  $E_{acc}$  and on surface erosion. Mechanism not fully understood.

## **Gradient Limits**

**SC cavities  $\approx$  50 MV/m**

**90% of theoretical field limit given by critical B field**

**NC cavities  $\approx$  200 MV/m**

**5% of theoretical field limit given by Fowler-Nordheim law**

**Theoretical understanding of NC breakdown insufficient for safe design guidelines !**

***$\Rightarrow$  Design of high field NC structures has to rely on extrapolation of existing data plus extensive prototype power testing !***

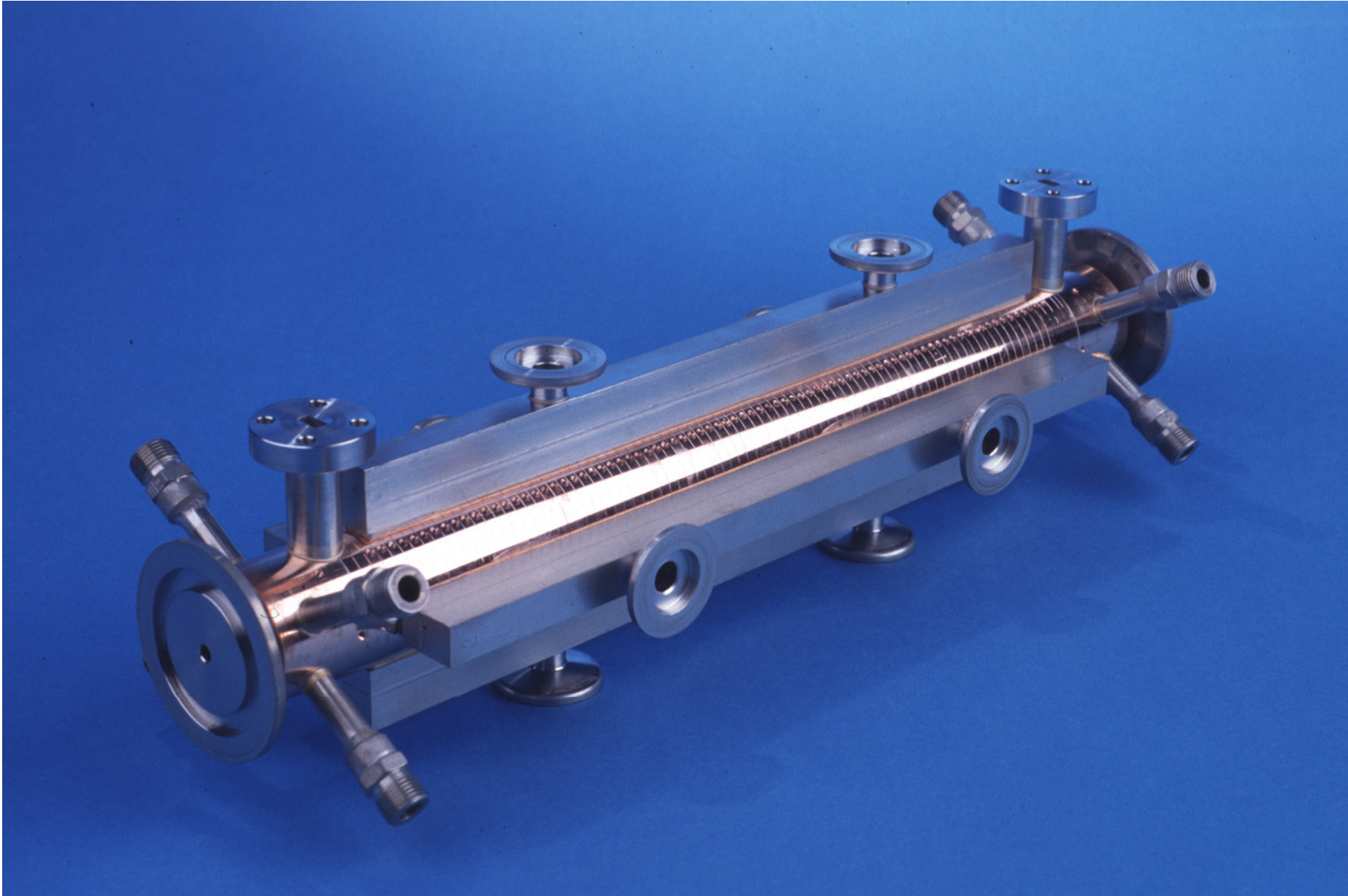

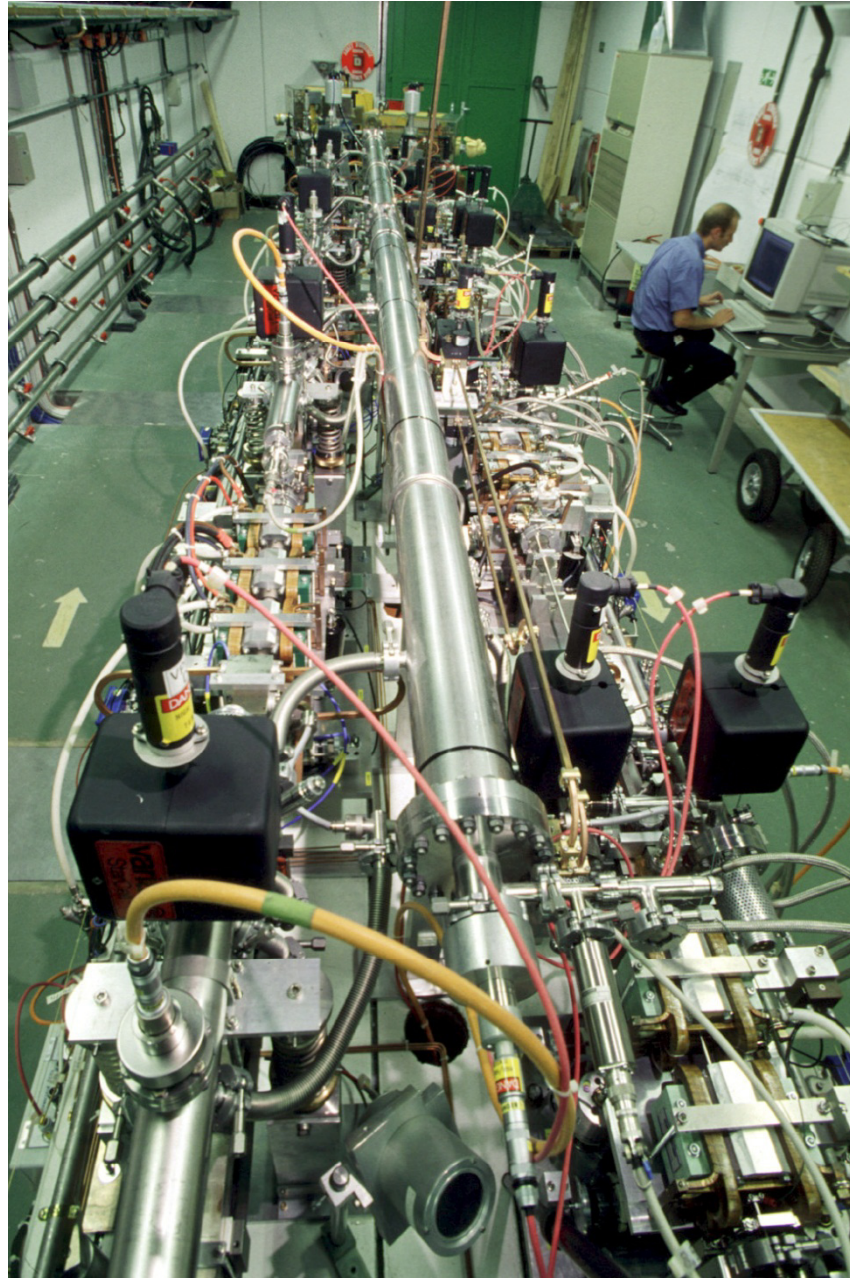



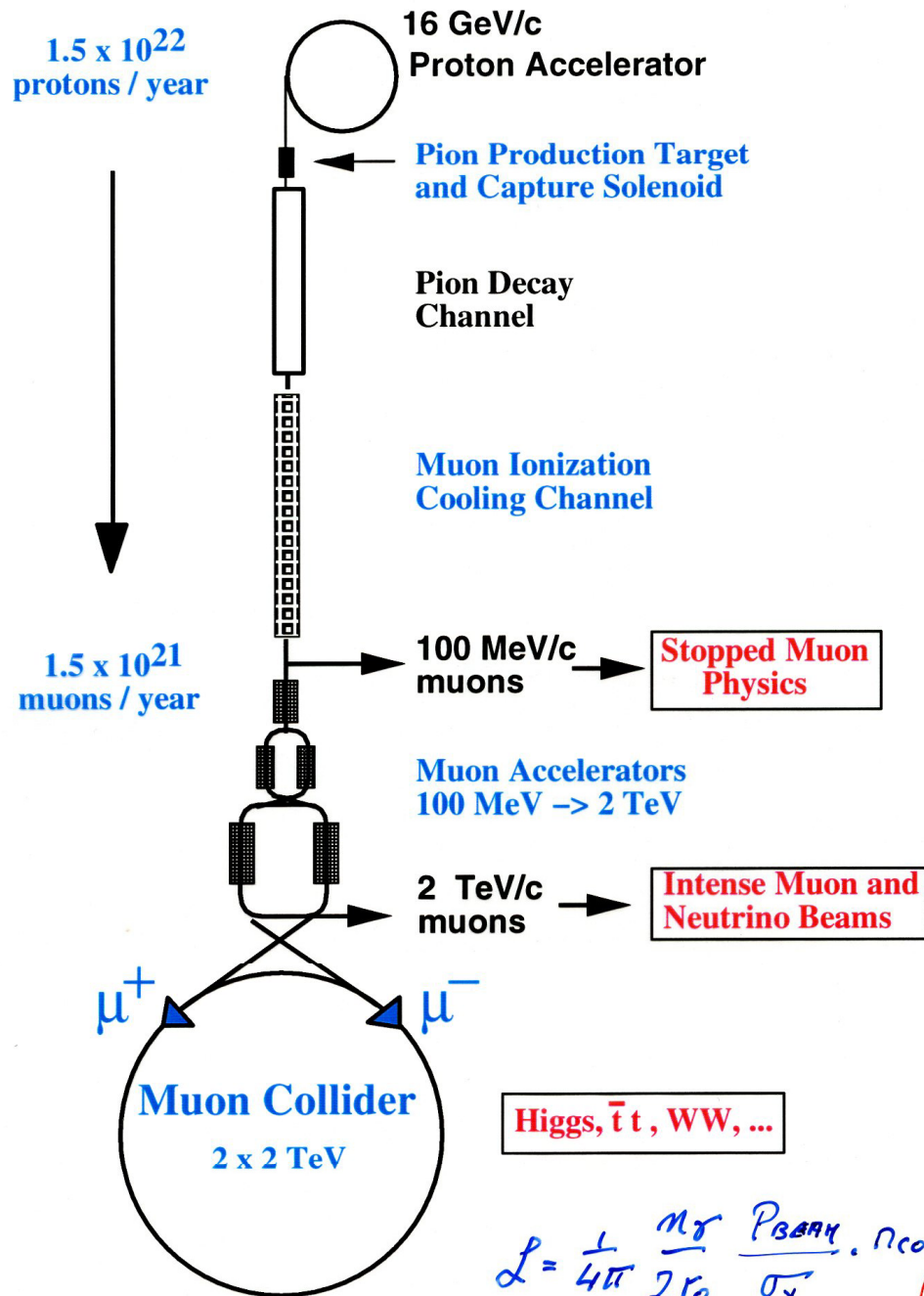

## Ionization Cooling

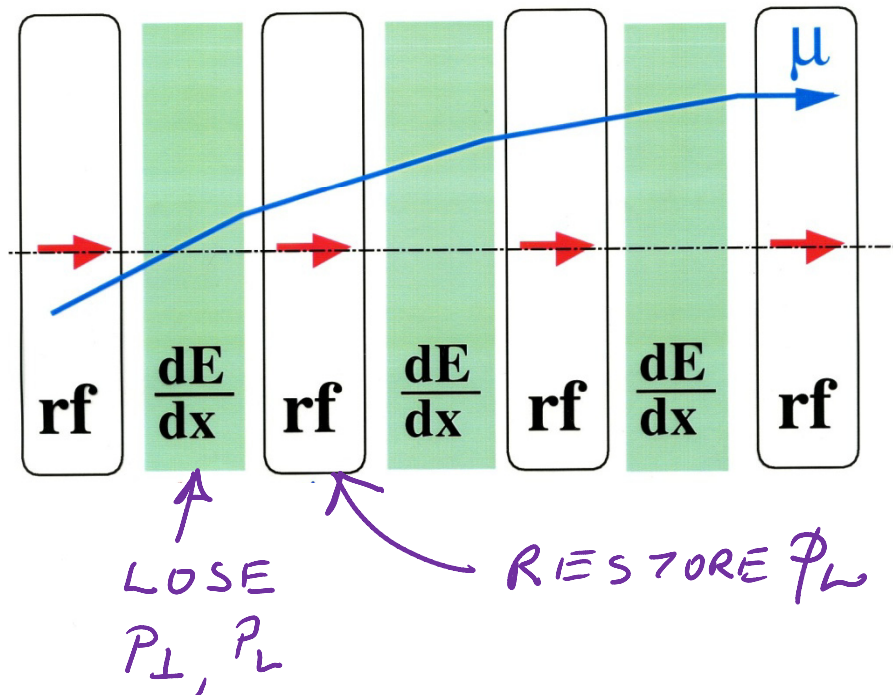

$$\mathcal{L} = \frac{1}{4\pi} \frac{n\sigma}{2r_0} \frac{P_{beam}}{\sigma} \cdot n_{collisions} \quad \parallel \neq 1$$

$$N_{\mu\mu} = \frac{r_0^2}{200}$$

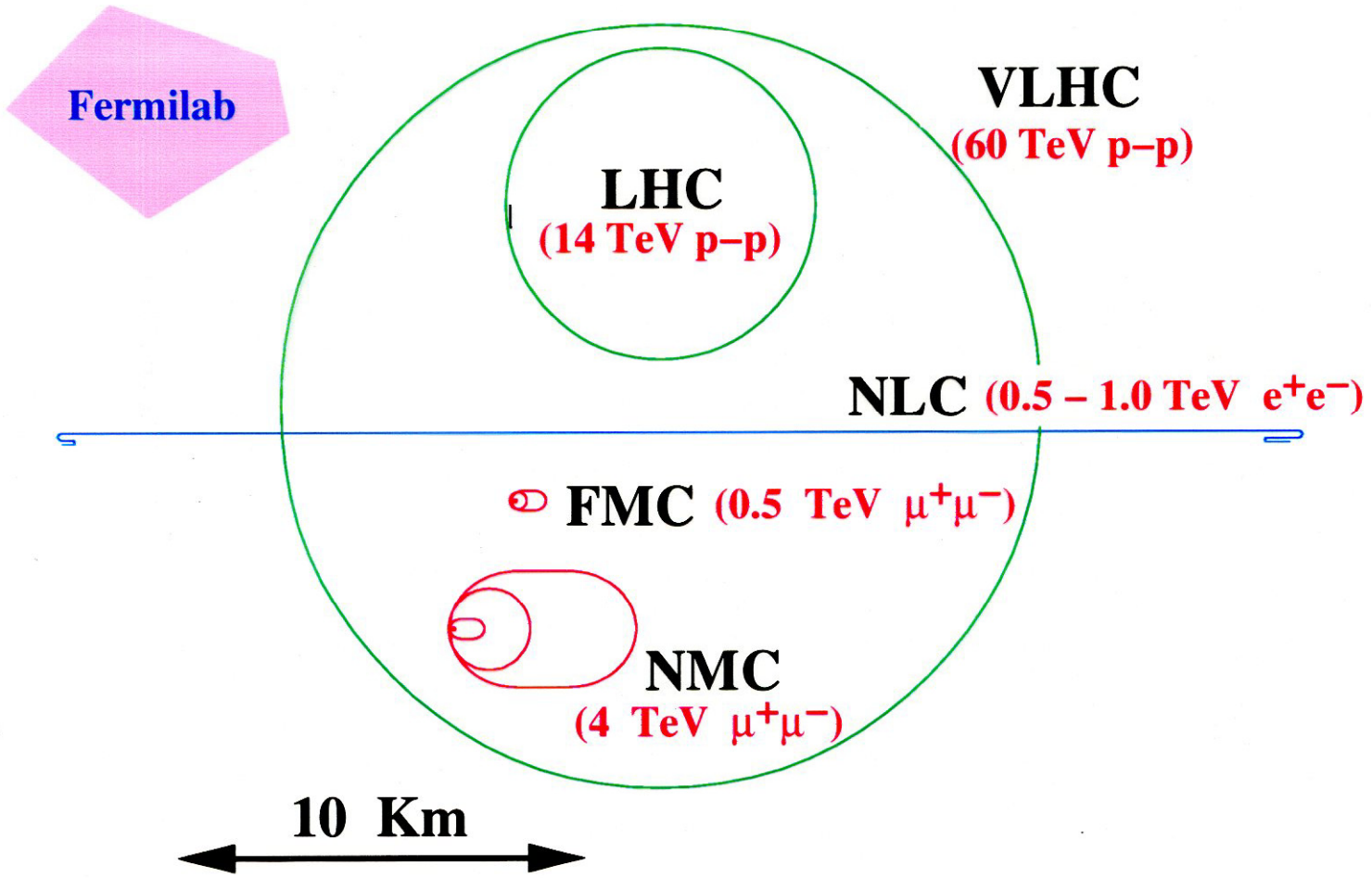

# Schematics of a Neutrino Factory (US Study IIa)

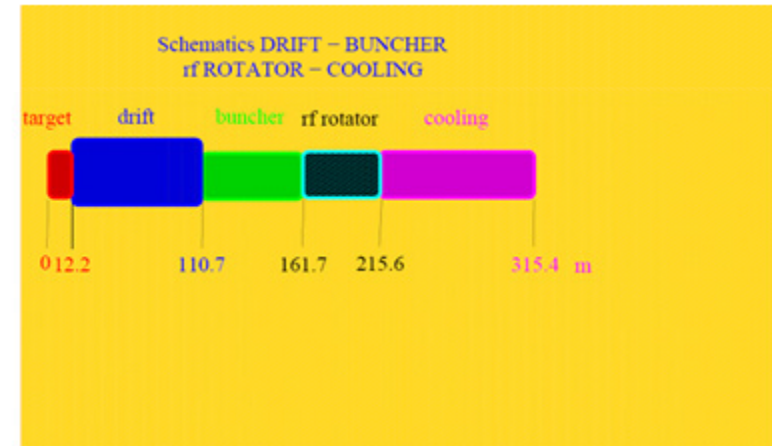
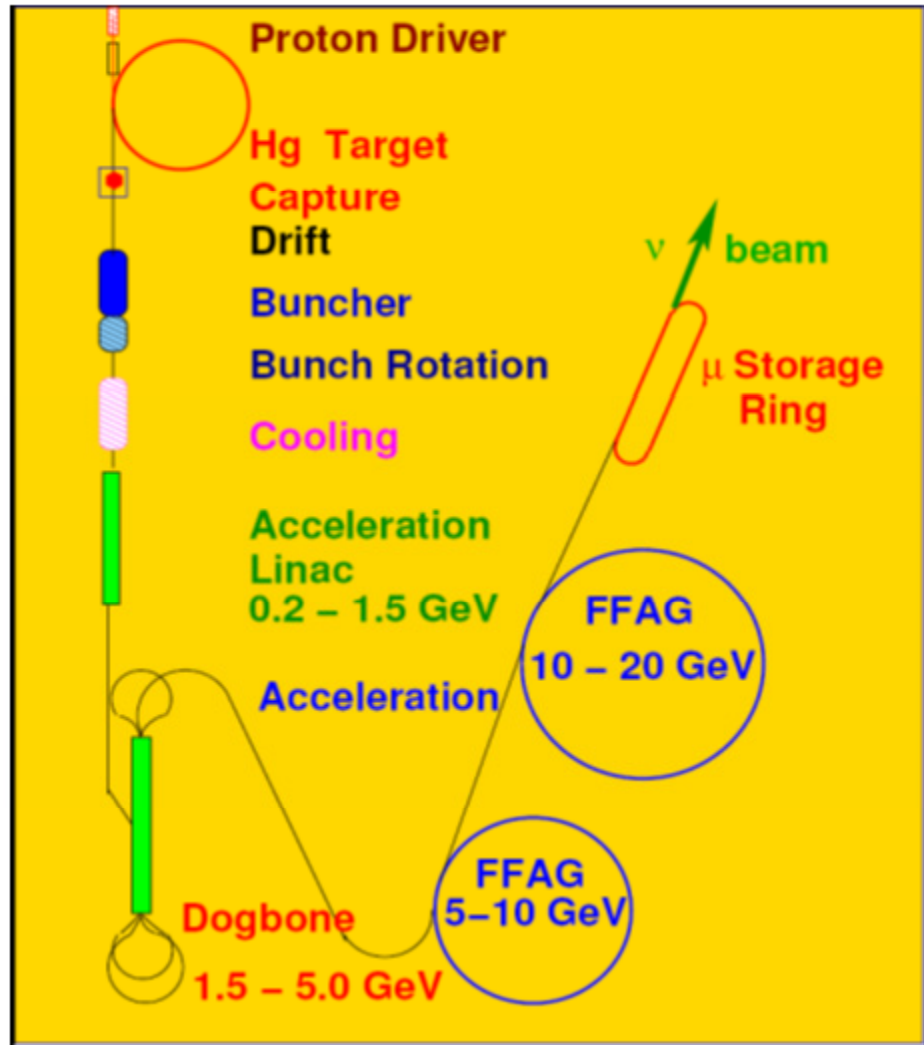

# Plasma Based Accelerators

- **Laser Wake Field Accelerator**

A single short-pulse of photons

- **Drive beam**

- **Trailing beam**

- **Plasma Wake Field Accelerator**

A high energy electron bunch

- **Wake: phase velocity = driver velocity**

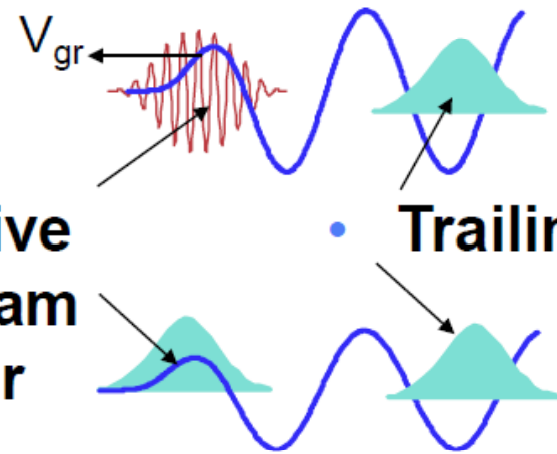

## Linear Plasma Wakefield Theory

---

$$\left(\partial_t^2 + \omega_p^2\right) \frac{n_1}{n_o} = -\omega_p^2 \left(\frac{n_b}{n_o} + k_p^2 \nabla^2 \sqrt{1 + \langle a_o^2 \rangle}\right)$$

Large wake if laser amplitude  $a_o = eE_o / m\omega_o c \sim 1$  or a beam density  $n_b \sim n_o$

And  $\tau_{\text{pulse}}$  of order  $\pi\omega_p^{-1} \sim 100\text{fs}$  ( $10^{17}/n_o$ )<sup>1/2</sup> and spot size  $c/\omega_p$ :

$\Rightarrow P \sim 15 \text{ TW } (\tau_{\text{pulse}}/100\text{fs})^2$	laser
$\Rightarrow Q / \tau_{\text{pulse}} = 1\text{nCoul}/100\text{fs} \quad (\sim 10 \text{ kA})$	beam

$$\nabla \cdot E = -4\pi en_1 \Rightarrow eE = \frac{n_1}{n_o} \sqrt{\frac{n_o}{10^{16} \text{ cm}^{-3}}} 10 \text{ GeV}/m \cos \omega_p (t - z/c)$$

---

# Plasma Wakefield Accelerators

(Blowout Regime)

Rosenzweig et al. 1990

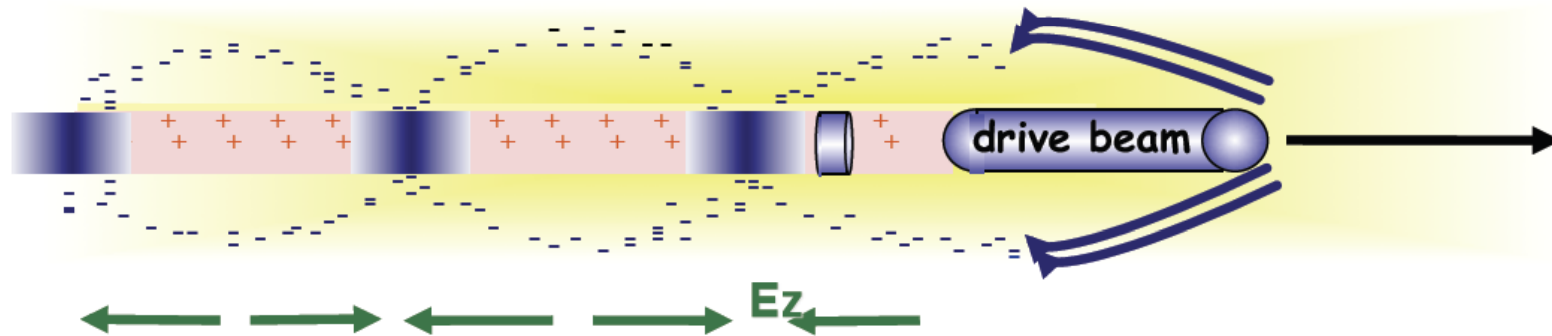

- **Plasma ion channel** exerts restoring force => space charge oscillations

Linear focusing force on beams ( $F/r=2\pi ne^2/m$ )

- Synchrotron radiation
- Scattering

- **Nonlinear Theory** : *W. Lu et al., PRL 16, 16500 [2006]*

# Plasma Wakefield Acceleration Experiments @ SLAC

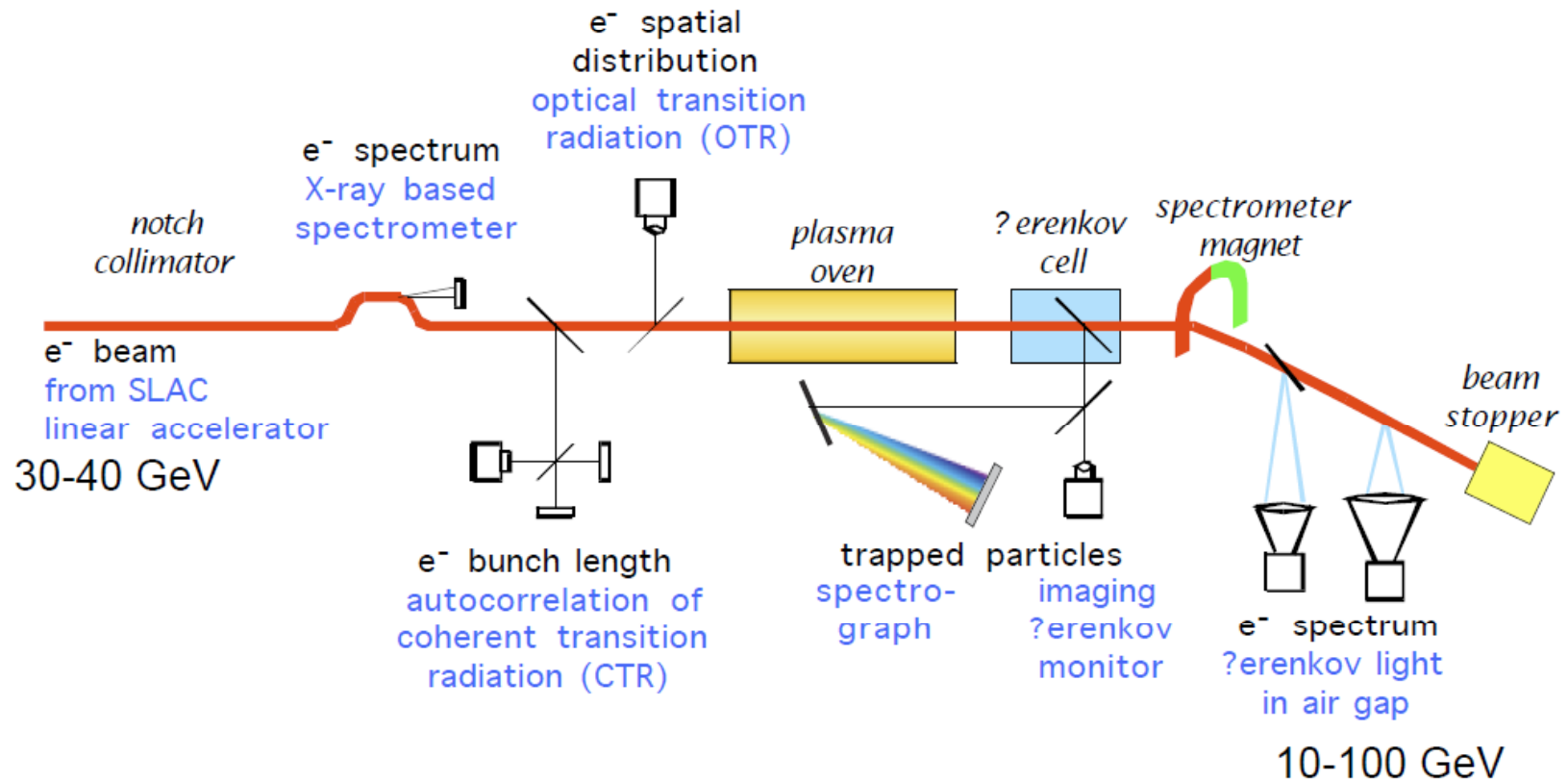



# Energy Gain Scales Linearly with Length

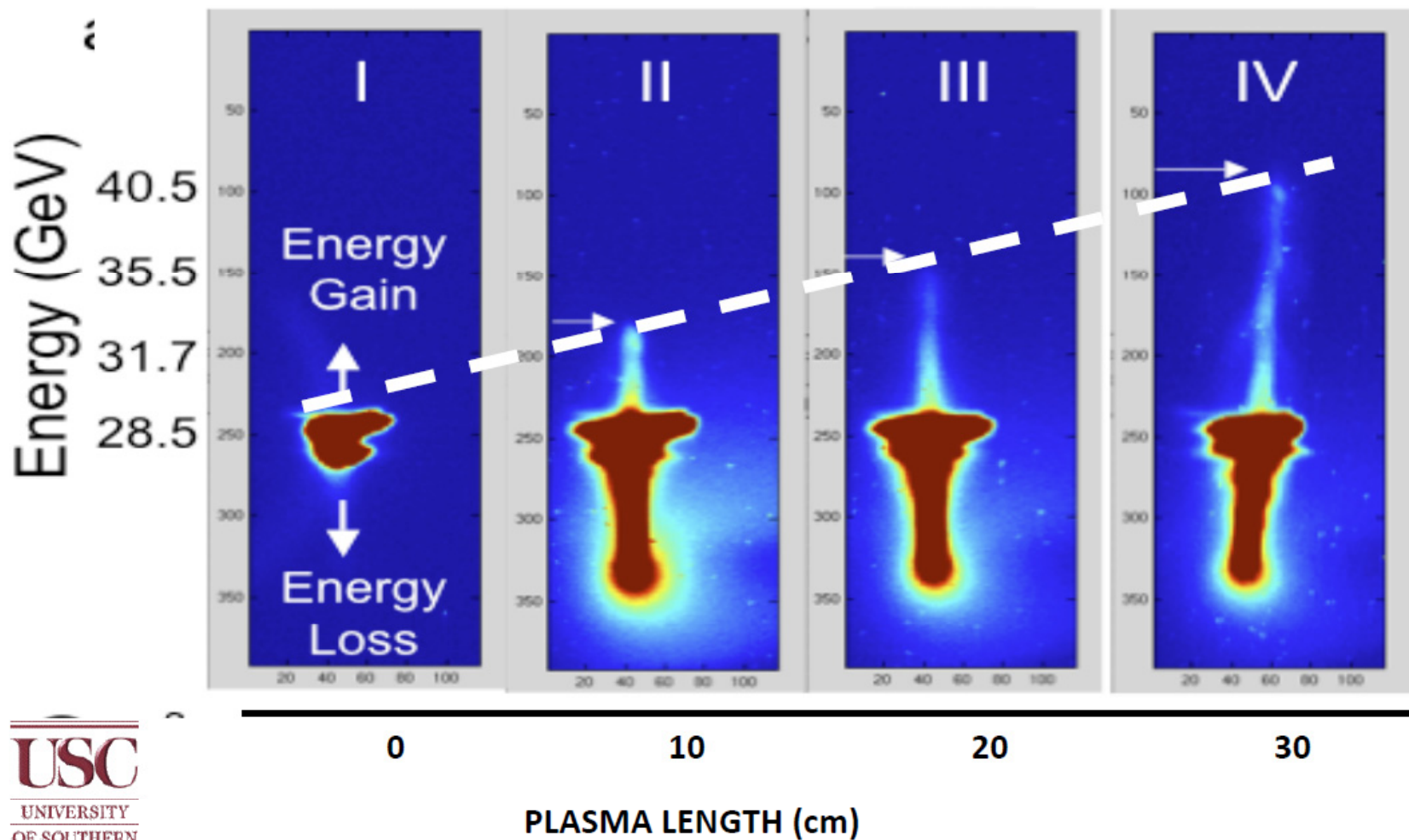



# 42 GeV e-beam energy doubled by PLASMA WAKEFIELD ACCELERATOR

I. Blumenfeld et al., Nature 455, 741, 2007

Plasma wakefield in the "bubble" regime

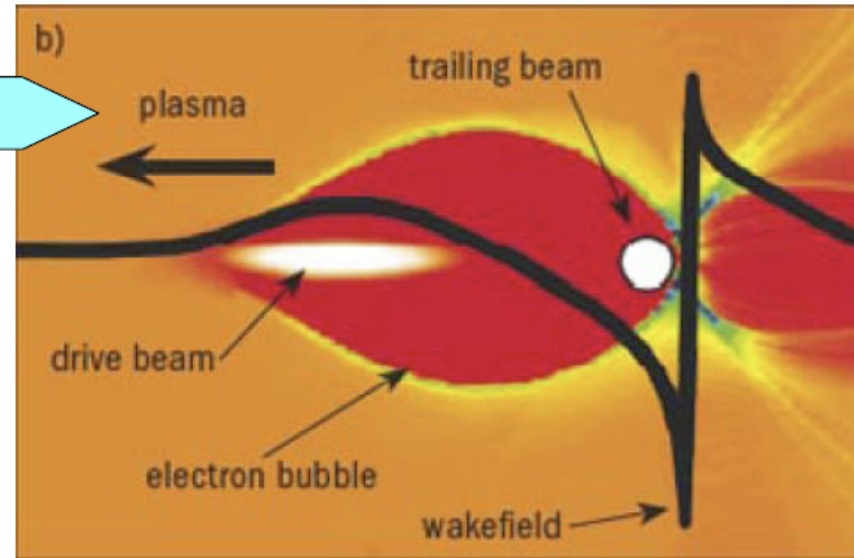
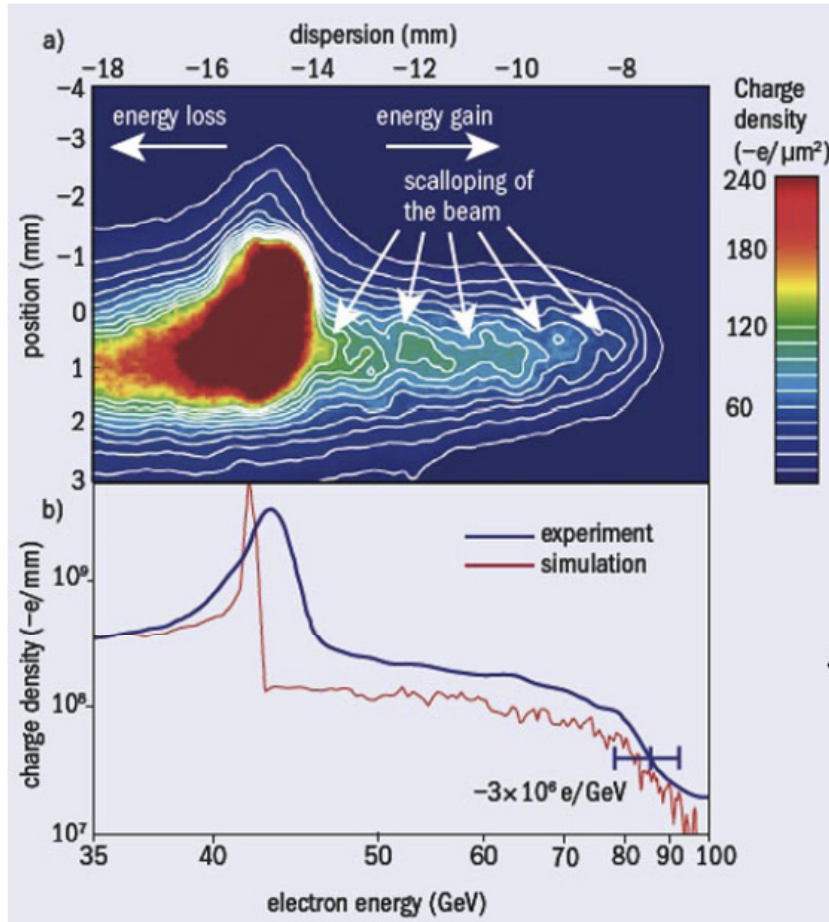

Energy spectrum of E167 SLAC Plasma Accelerator Experiment for the 42 GeV electron beam after passing through a 85 cm long plasma of density  $2.7 \times 10^{17} \text{ cm}^{-3}$

# From Science to a Collider

---

## Requirements for High Energy Physics

- \* High Energy
- \* High Luminosity (event rate)
  - $L = f_{\text{rep}} N^2 / 4\pi\sigma_x\sigma_y$
- High Beam Power
  - ~20 MW
- \* High Beam Quality
  - Energy spread  $\delta\gamma/\gamma \sim .1 - 10\%$
  - Low emittance:  $\varepsilon_n \sim \gamma\sigma_y\theta_y \ll 1$  mm-mrad
- \* Reasonable Cost : less than \$5 B for 1 TeV CM
  - Gradients > 100 MeV/m
  - Efficiency > few %

# A Concept for a Plasma Wakefield Accelerator Based Linear Collider

- TeV CM Energy
- 10's MW Beam Power for Luminosity
- Positron Acceleration
- Conventional technology for particle generation & focusing

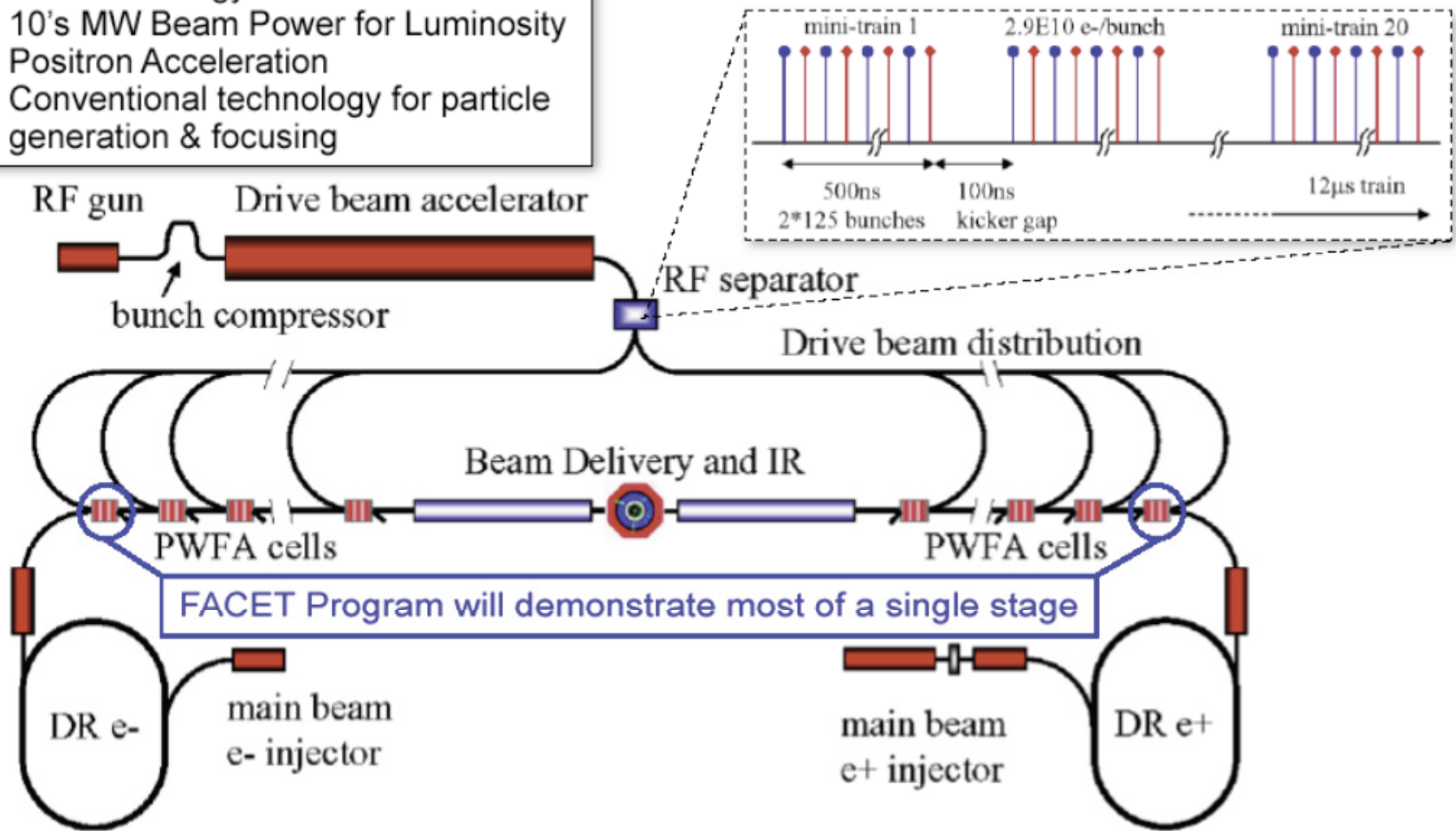

FACET Program will demonstrate most of a single stage

# FACET: Facility for Advanced Accelerator Experimental Tests

- \* Use the SLAC injector complex and 2/3 of the SLAC linac to deliver electrons and positrons
  - Compressed 25 GeV beams  $\rightarrow$   $\sim$ 20 kA peak current
  - Small spots necessary for plasma acceleration studies
- \* Two separate installations
  - Final bunch compression and focusing system in Sector 20
  - Expanded Sector 10 bunch compressor for positrons

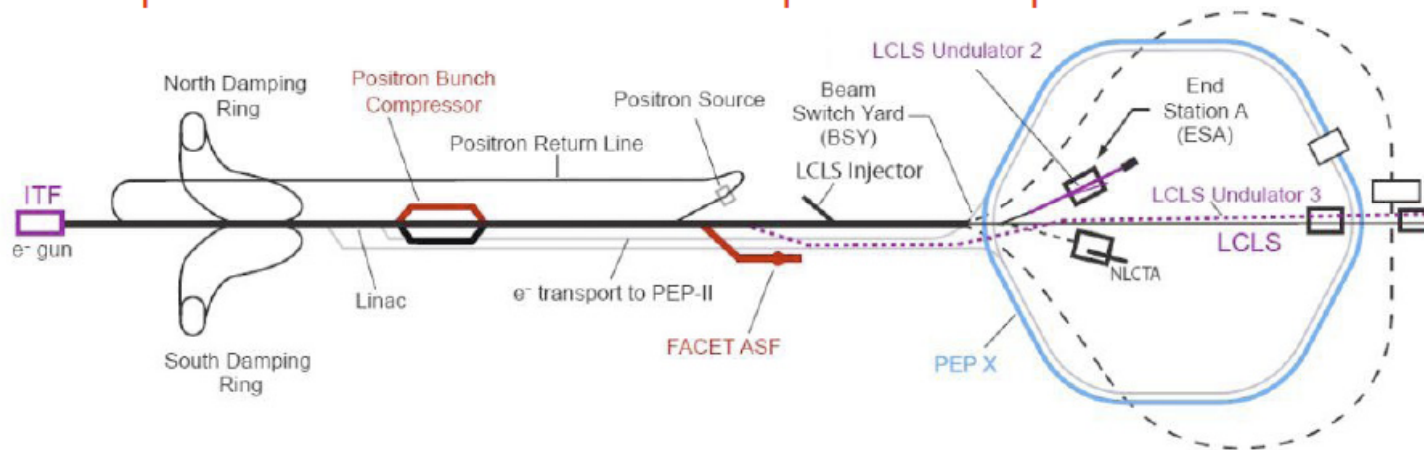



# Channel guided laser-plasma accelerator has produced GeV beams



- Higher power laser  $\Delta W[\text{GeV}] \sim I[\text{W}/\text{cm}^2]/n[\text{cm}^{-3}]$
- Lower density, longer plasma

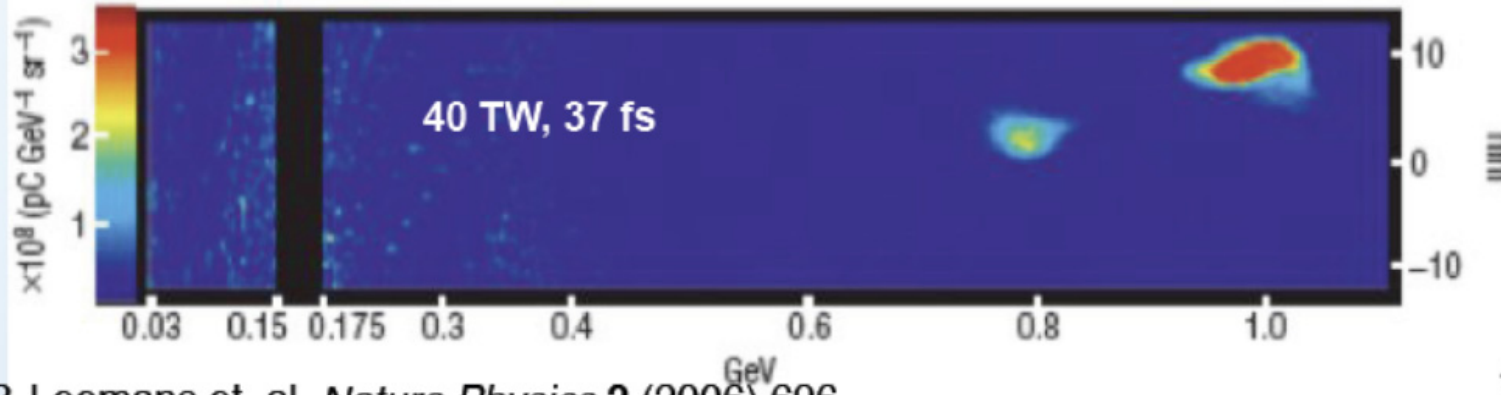
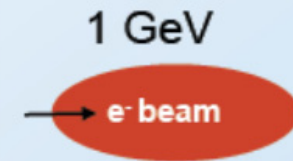
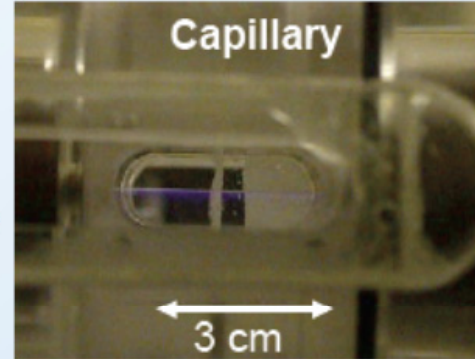
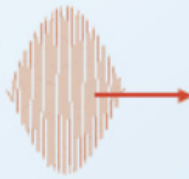
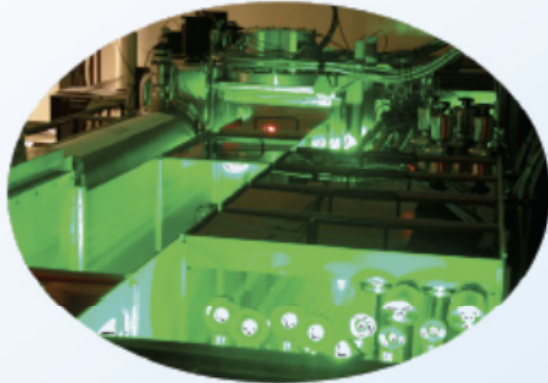

W.P. Leemans et. al, *Nature Physics* 2 (2006) 696



# 10 GeV module is suitable building block for an LPLC

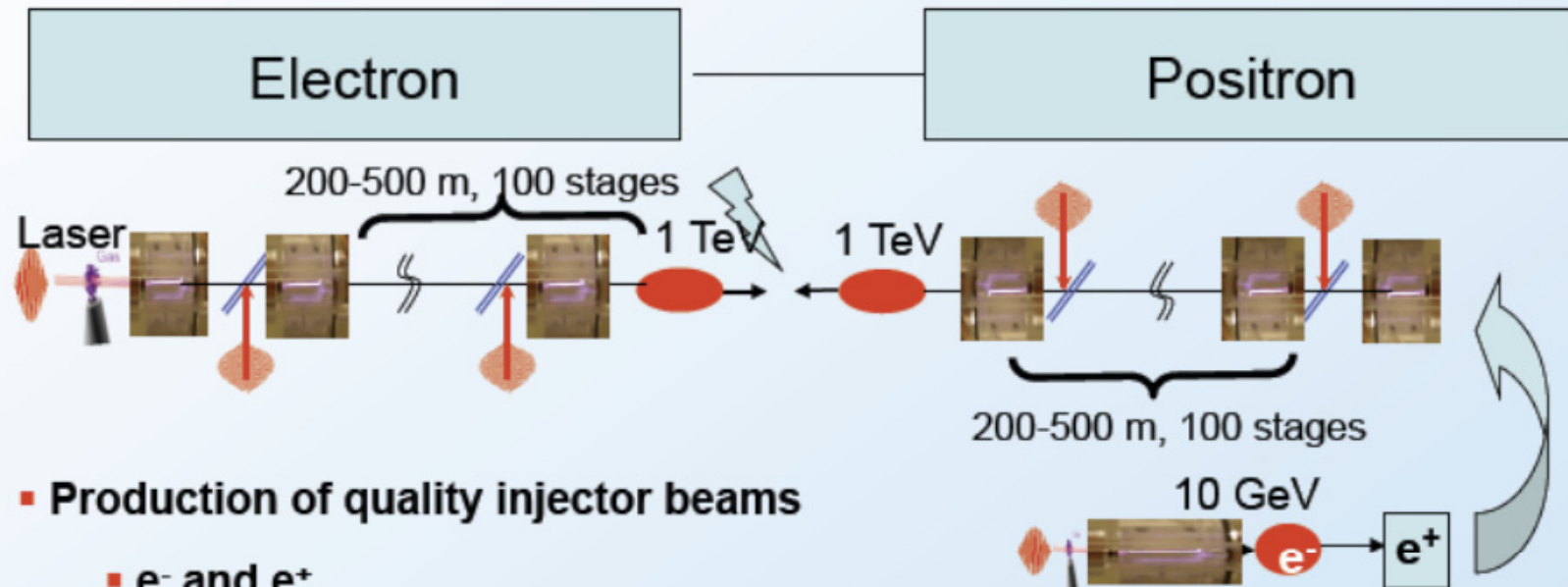

- Production of quality injector beams
  - $e^-$  and  $e^+$
- Linac structure: length, density, channel shape, collisions, emittance,...
- Power source: wavelength, pulse energy, pulse duration, pulse shape, focal spot size and shape, rep rate,...
- How to handle all this power?
- How to focus the beams?
- And many more questions...



## BELLA Project scope

- High rep rate (1 Hz), Petawatt class laser (>40 J in < 40 fs)
- Laser bay and target area
- Laser diagnostics to verify CD-4 goals

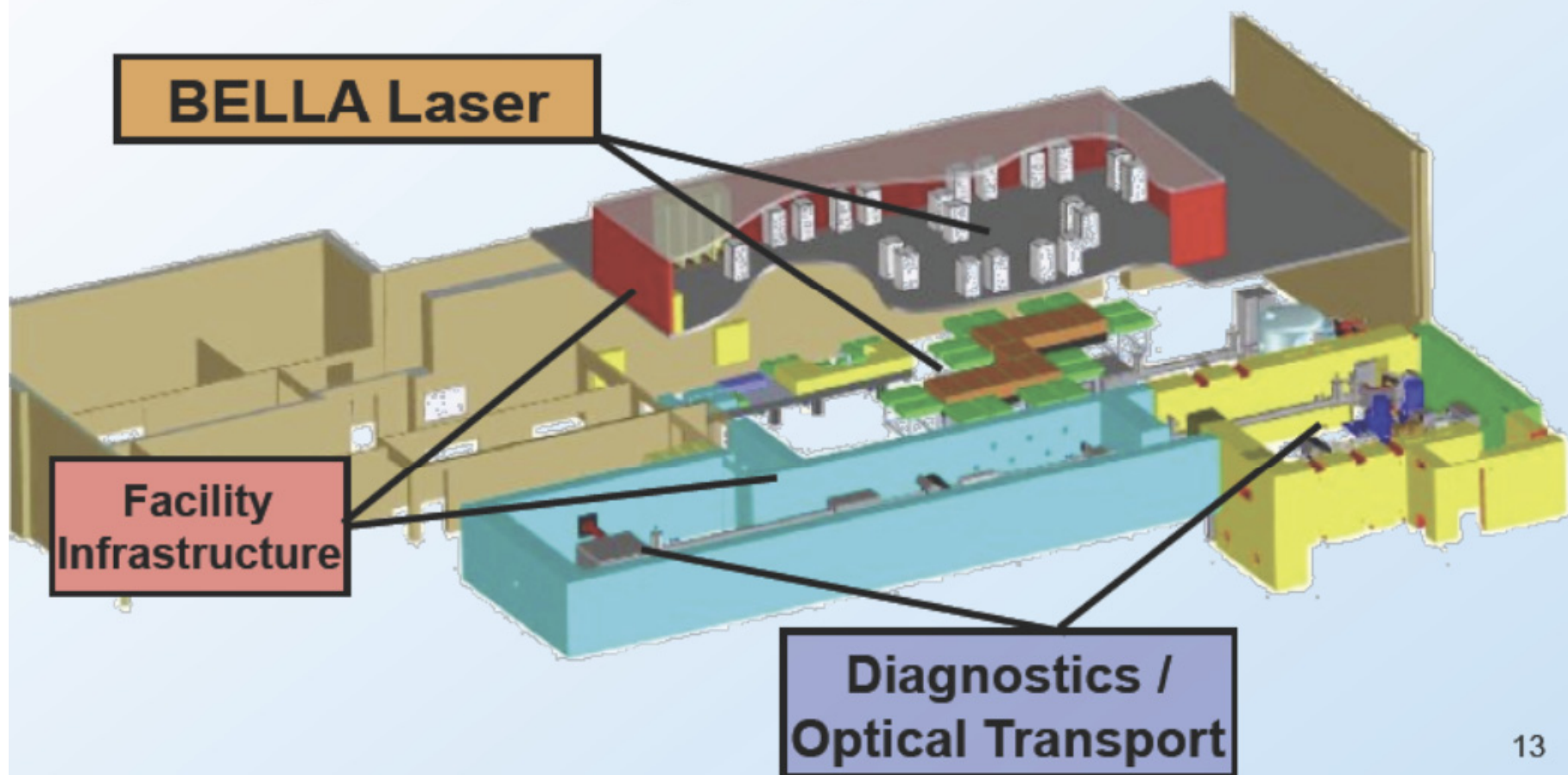



## Example of R&D with BELLA -- 10 GeV module



Multi-GeV beams

- Two-stage design
- Need 40 J in 40 fs laser pulse
- BELLA Project: 1 PW, 1 Hz laser

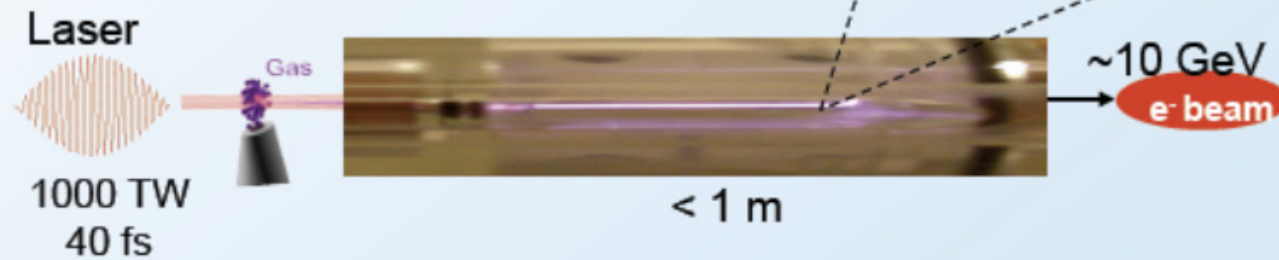

- Will be followed by staging at multi-GeV energies with BELLA
- 10 GeV beam will allow positron production experiments



# 1 GeV capillary accelerator experiment at LBNL/Oxford U.

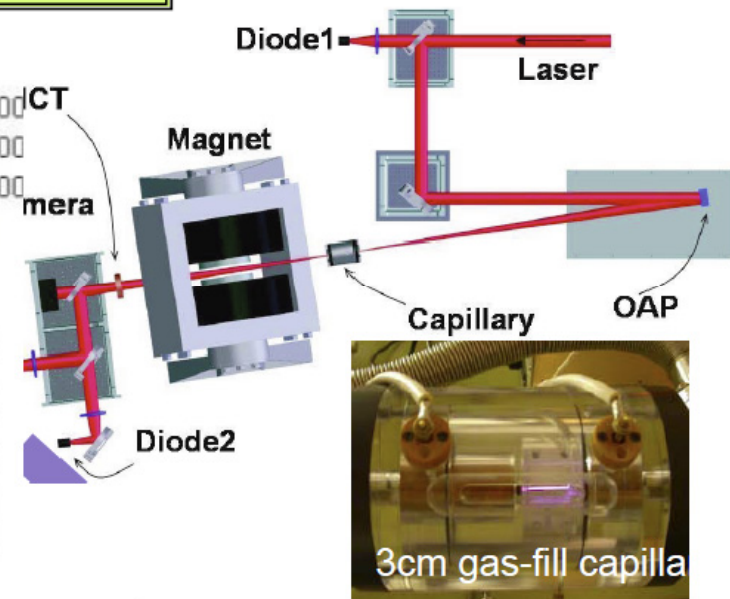
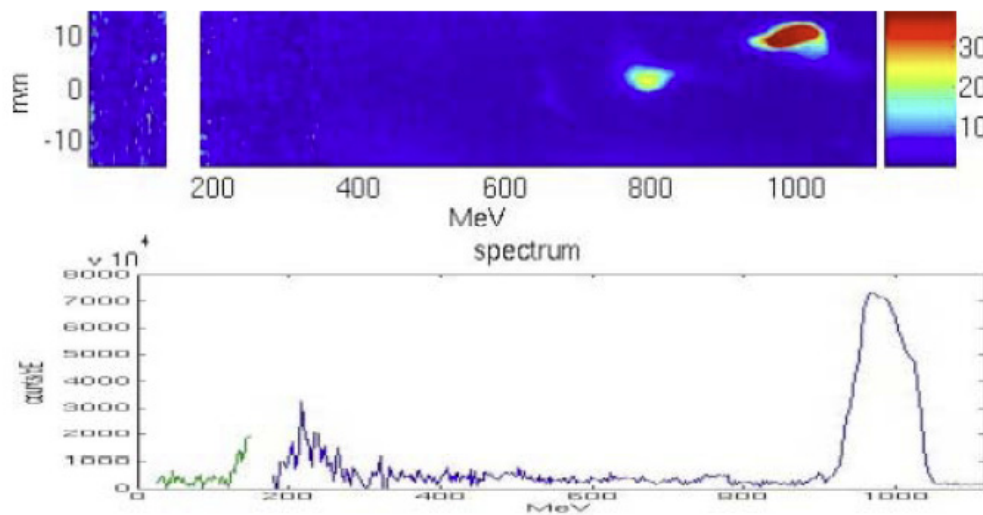

# 0.56 GeV capillary accelerator experiment at CAEP/KEK

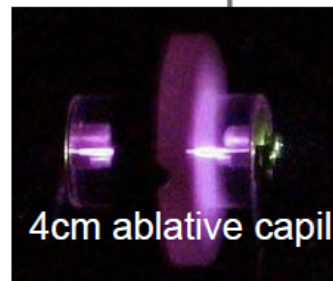
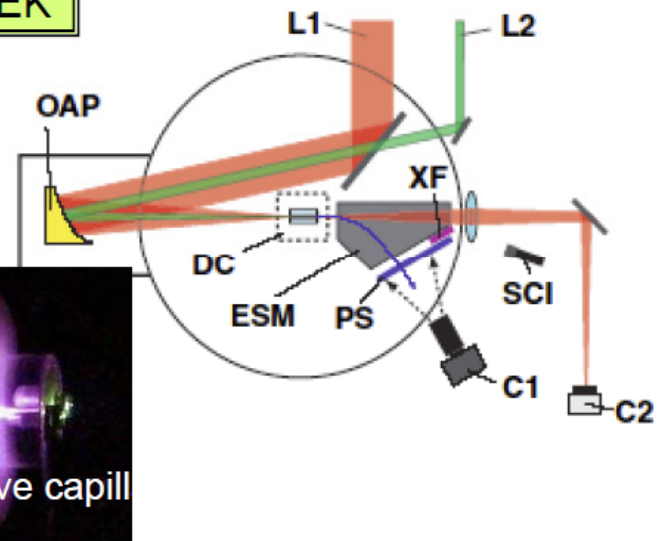
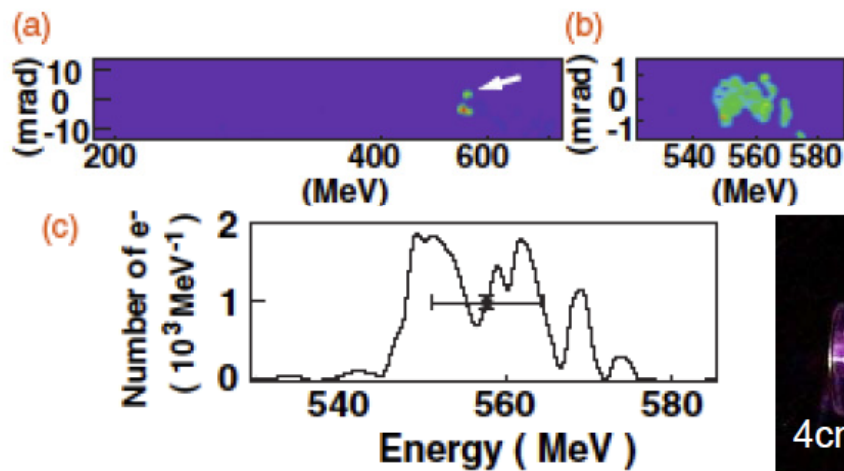

# Laser-driven table-top X-ray Free Electron Laser

Kilometer-scale X-ray FEL

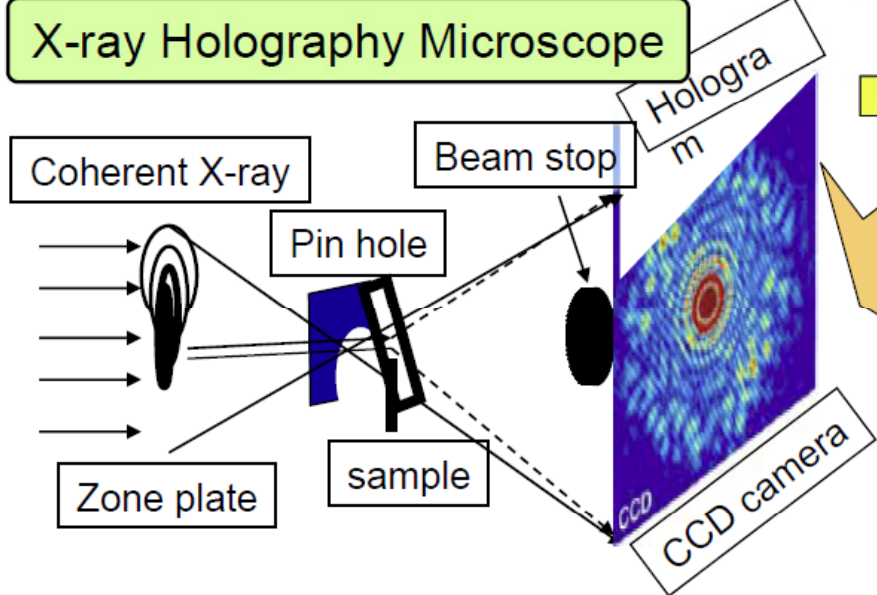
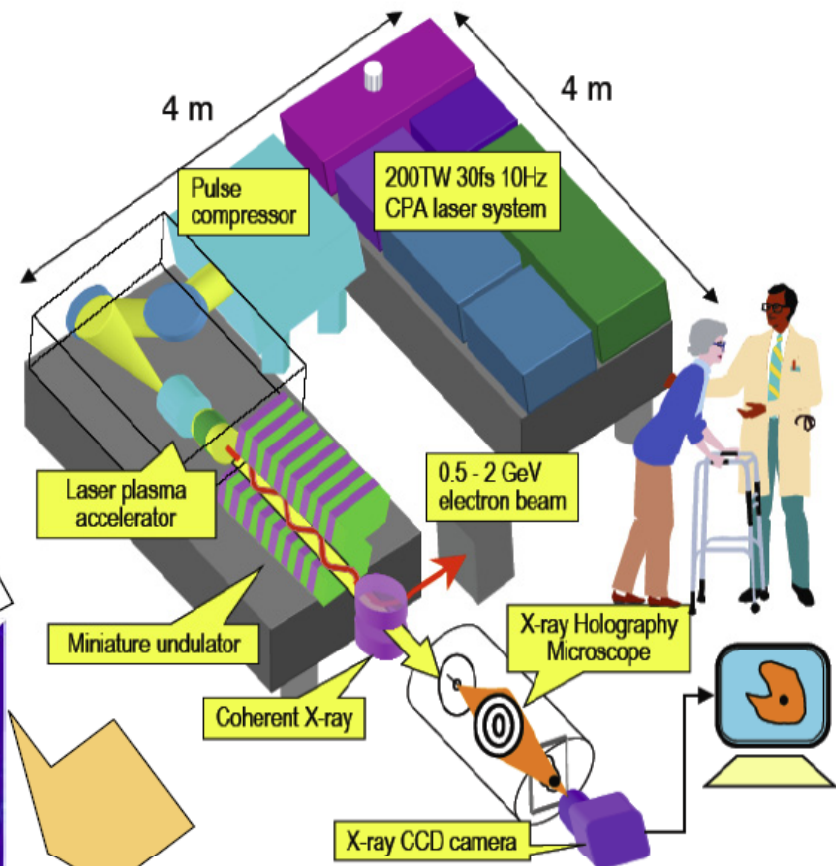
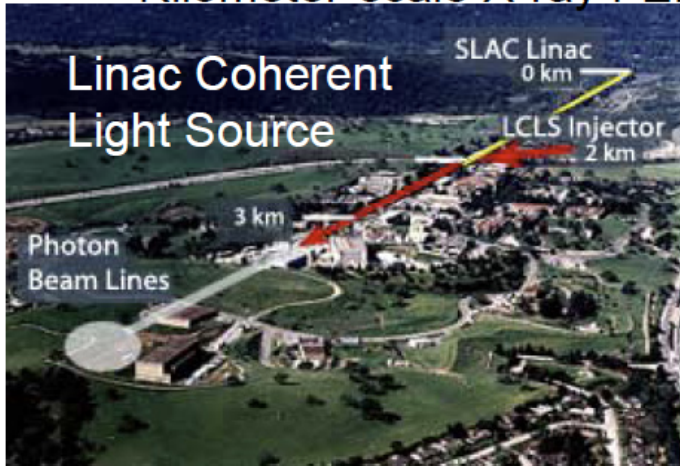

**The dream of realizing accelerator driven (subcritical reactor) system and nuclear waste transmutation system comes true with high power superconducting linacs !**

**Subcritical reactor alone**

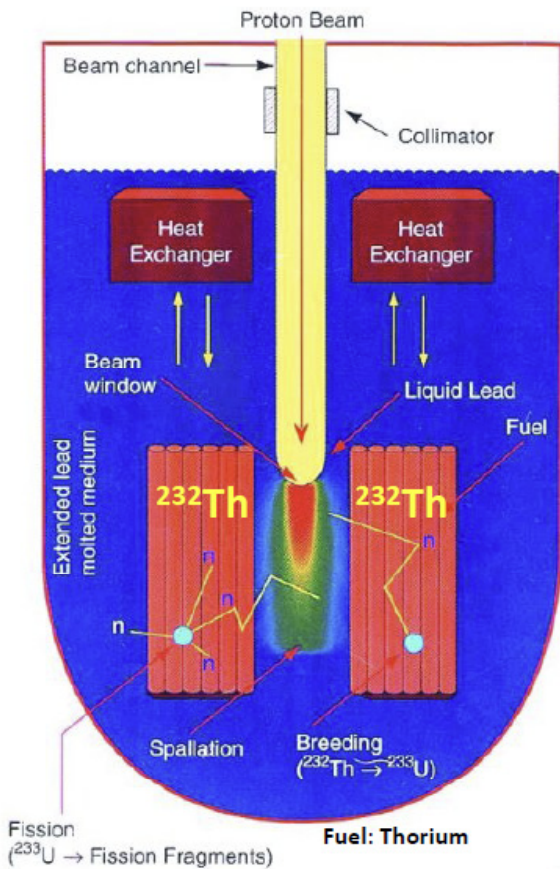

**Electric power generation & nuclear transmutation**

**Accelerator-driven System (ADS) as Dedicated Transmutation System**

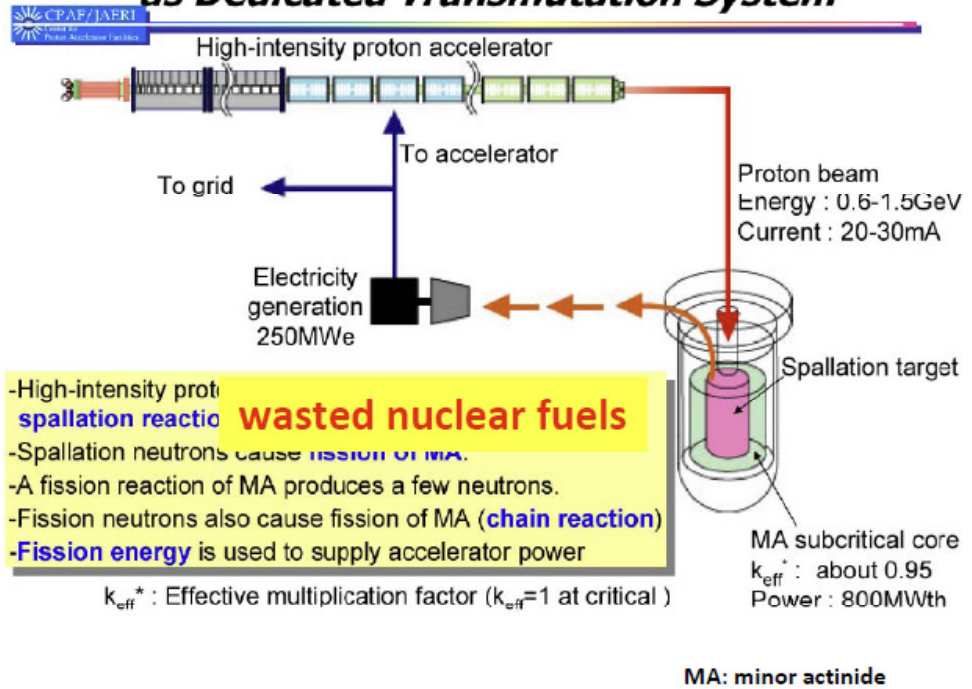

- High-intensity proton **wasted nuclear fuels**
  - Spallation neutrons cause **transmutation**.
  - A fission reaction of MA produces a few neutrons.
  - Fission neutrons also cause fission of MA (**chain reaction**)
  - Fission energy** is used to supply accelerator power
- $k_{eff}^*$  : Effective multiplication factor ( $k_{eff}=1$  at critical )

## Idea of Proton Driven Inertial Fusion : Down

### Driver for Heavy Ion Inertial Fusion Program in US-VNL

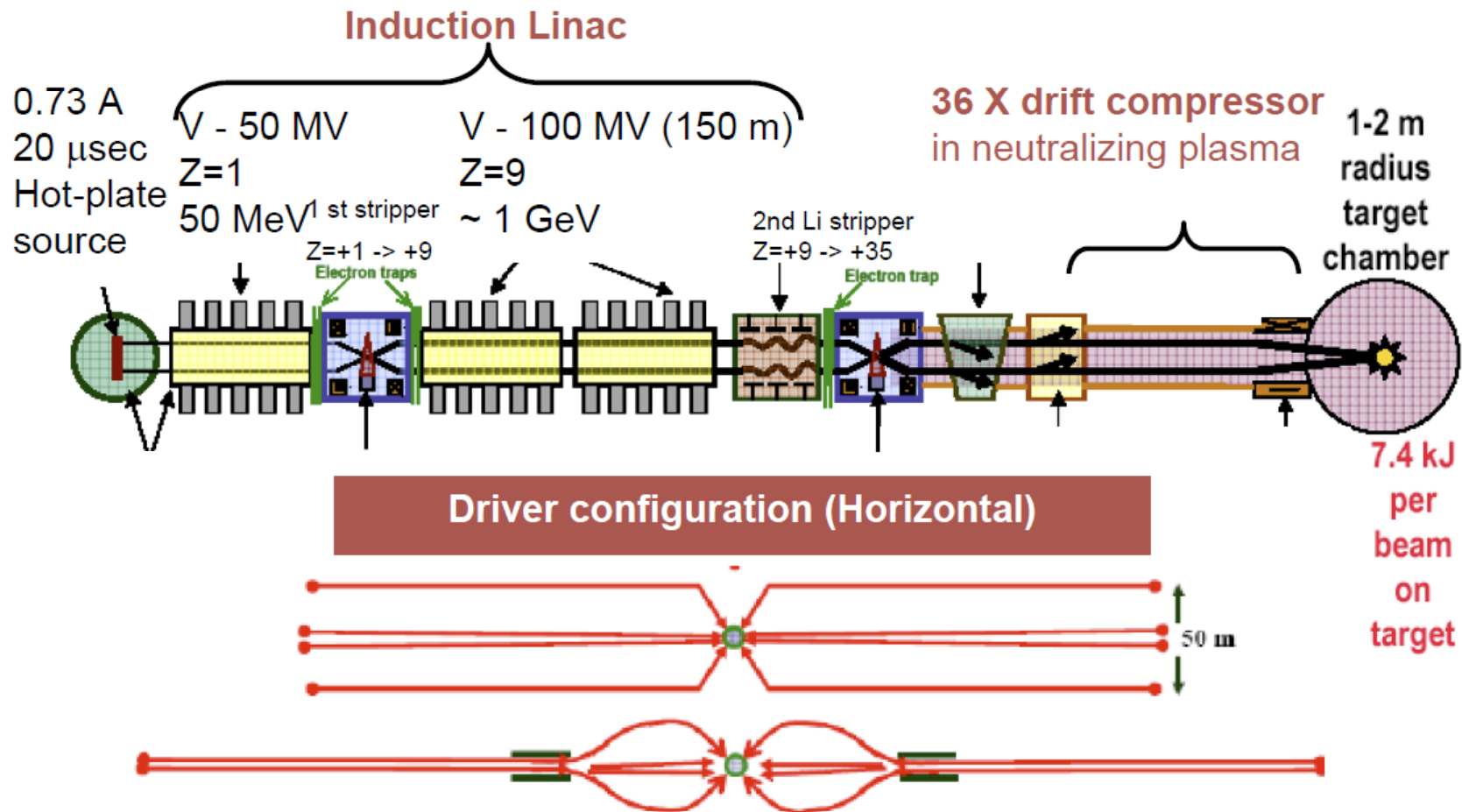

G.B.Logan (VNL), presented at HIF2008, Tokyo Japan