

SCATTERING EXPERIMENTS & STRUCTURE OF MATTER

- METHODOLOGY FOR INVESTIGATING SMALLER & SMALLER DISTANCE SCALES → RUTHERFORD SCATTERING (GEIGER & MARSDEN)
- YOU MUST ALREADY HAVE SEEN THIS
- LETS LOOK AT IT IN SIMPLEST TERMS
 - CLASSICAL MECHANICS TAKES YOU A LONG WAY
- ARCHETYPAL EXPERIMENT
- PROBES STRUCTURE OF MATTER
- REVEALS NATURE OF FORCE ACTING BETWEEN BEAM & TARGET

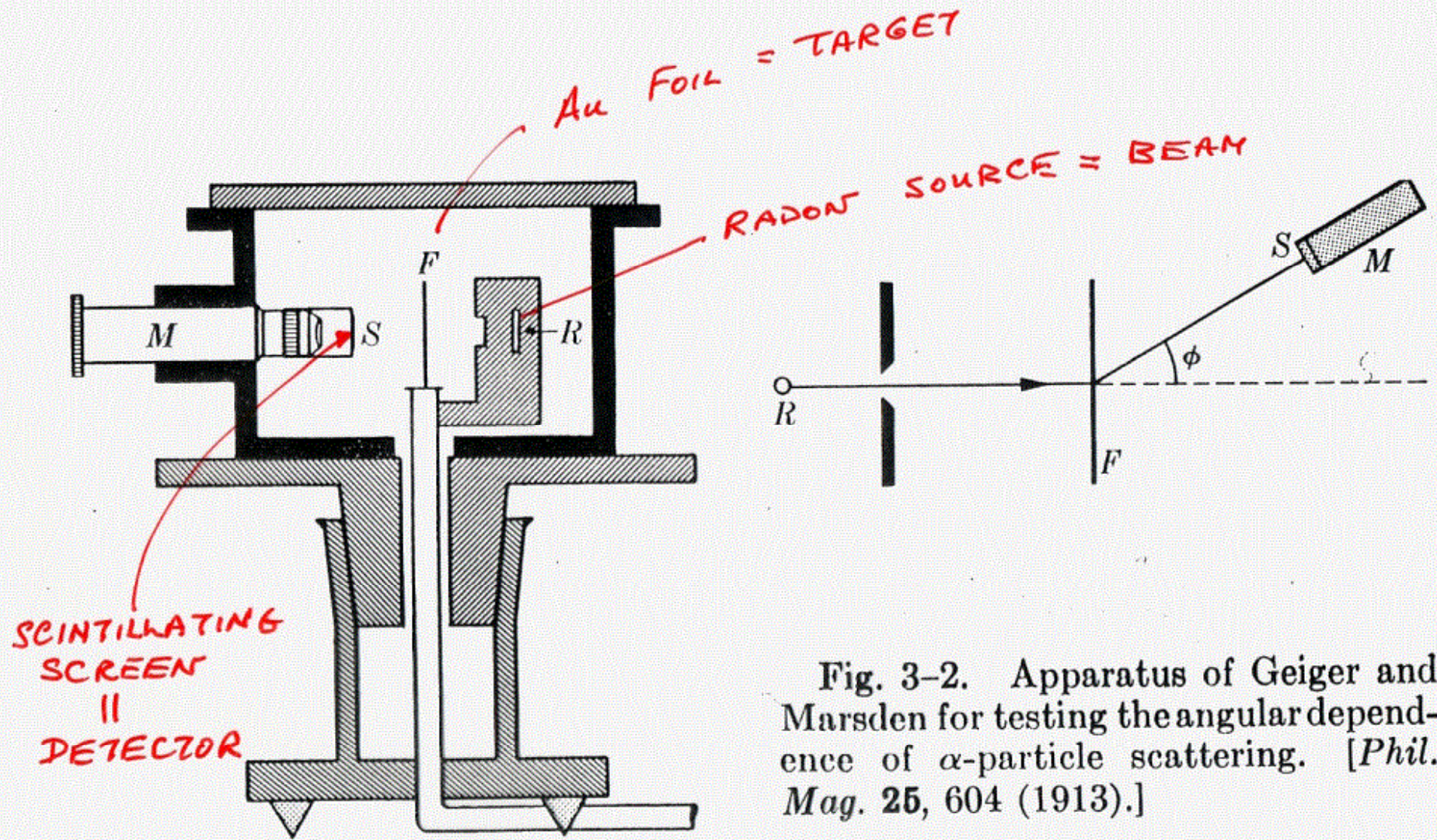
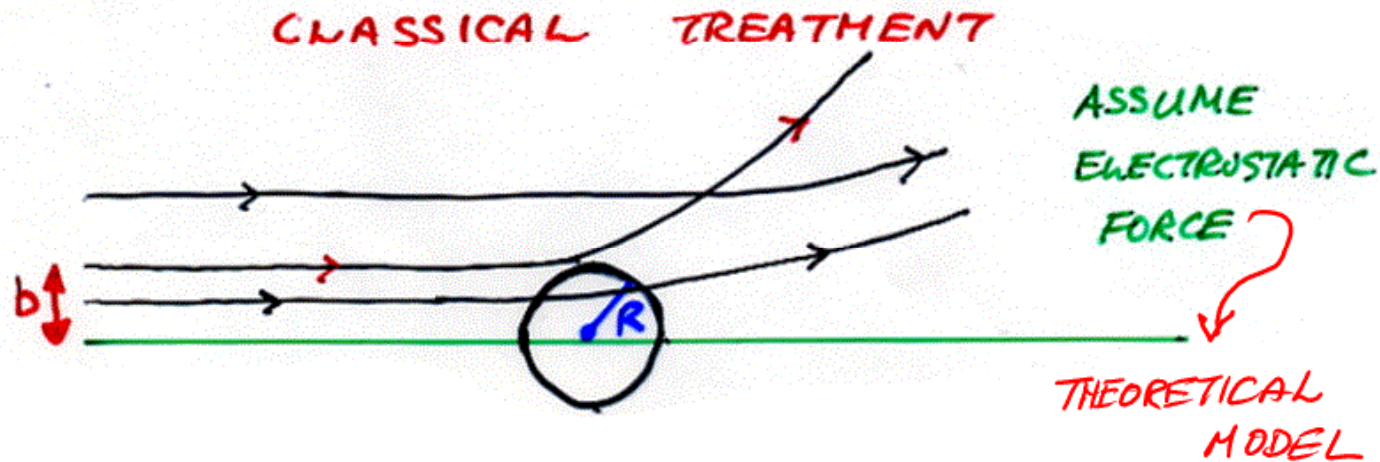

Fig. 3-2. Apparatus of Geiger and Marsden for testing the angular dependence of α -particle scattering. [*Phil. Mag.* 25, 604 (1913).]

RUTHERFORD SCATTERING - SIMPLE PICTURE



- GEIGER & MARSDEN FIRED 7.7 MeV α AT THIN GOLD FOIL
- WANTED TO UNDERSTAND DISTRIBUTION OF +VE CHARGE WITHIN THE ATOM.
- GREATEST DEFLECTION - PROJECTILE GRAZES PERIPHERY OF TARGET
 - $b > R$ ELECTROSTATIC REPUSSION FALLS OFF
 - $b < R$ PASSES THRU CHARGE SOME CHARGE REPELS α ONE WAY, SOME OTHER
- WHAT IS b CORRESPONDING TO MAXIMUM DEFLECTION? I.E. WHAT IS SIZE OF NUCLEUS?

IDEALIZED MODEL FOR SIMPLE CALCULATION

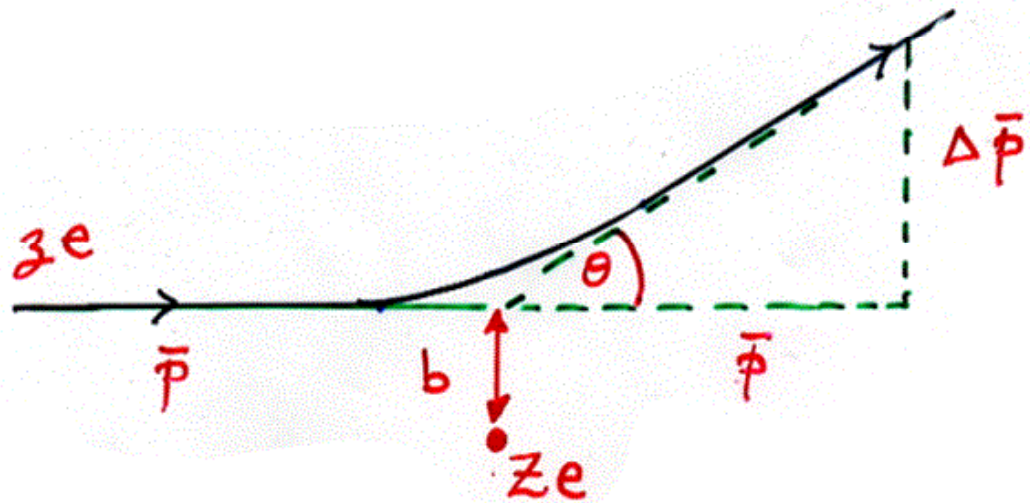

NON RELATIVISTIC

$$M_\alpha \gg \phi_\alpha$$



$$E^2 = p^2 + m^2$$

- ASSUME THAT θ IS SMALL
- ALONG LINE OF FLIGHT α SLOWED BY COULOMB REPULSION ON APPROACH, AFTER SCATTER ACCELERATED BY SAME AMOUNT $\Rightarrow M_{\text{NUCLEUS}} \gg M_\alpha$
- APPROXIMATE - ALL DEFLECTION AN IMPULSE TRANSVERSE TO ORIGINAL DIRECTION, AS α PASSES NUCLEUS

$$\text{POTENTIAL} = \frac{ze}{b}$$

\rightarrow ASSUMES ONLY COULOMB FORCE ACTING
 \hookrightarrow "MODEL"

FORCE ACTING ON α , b AWAY FROM NUCLEUS

$$F = \frac{Zz e^2}{b^2}$$

• APPROXIMATION \rightarrow FORCE ACTS FOR DISTANCE b ON EITHER SIDE OF NUCLEUS, ALWAYS NORMAL TO ORIGINAL DIRECTION OF α ,

TIME FORCE ACTS FOR $\rightarrow \Delta t = \frac{2b}{v}$ \leftarrow VELOCITY

$$\Delta p / \Delta t = F \rightarrow \Delta p = F \cdot \Delta t$$

DEFINITION OF FORCE \nearrow

$$\Delta p = \frac{Zz e^2}{b^2} \cdot \frac{2b}{v}$$

APPROXIMATELY DEFLECTION (SCATTERING) ANGLE:

$$\sin \theta \approx \theta \approx \frac{\Delta p}{p}$$

$$\theta \approx \frac{Zz e^2}{b^2} \cdot \frac{2b}{v} \cdot \frac{1}{mv}$$

NON
RELATIVISTIC

$$\theta = 0.1$$

$$\frac{z}{\theta} = 20$$

$$\cot \frac{\theta}{2} = 20$$

$$\text{YES } \frac{z}{\theta} \approx \cot \frac{\theta}{2}$$

$$\theta \approx \frac{Zz e^2}{b} \cdot \frac{2}{mv^2}$$

$$b \approx \frac{Zz e^2}{mv^2 \theta} \cdot 2$$

"CORRECT"
TREATMENT

$$\frac{Zz e^2}{2E} \cdot \frac{\cot \frac{\theta}{2}}{2}$$

• GEIGER & MARSDEN OBSERVED MAXIMUM DEFLECTIONS OF ~ 1 RADIAN (NOT SMALL)

• PWT $b = R$ — RADIUS OF NUCLEUS

$\theta = 1$ RADIAN

$$R = 2 \cdot \frac{Zz e^2}{mv^2}$$

$$= 2 \cdot \frac{Zz e^2}{2E}$$

$$R = \frac{Zz e^2}{E}$$

$$\theta = 1 \text{ RAD}$$

$$\frac{z}{\theta} = 2$$

$$\cot \frac{\theta}{2} = 1.83$$

NON RELATIVISTIC

$$E = \frac{1}{2} m v^2$$

$$R = 2Z e^2 / E$$

FOR α ON GOLD FOIL $z=2$, $Z=79$

AND $E = 7.7 \text{ MeV}$ NON RELATIVISTIC

$$R = \frac{2 \times 79 \times e^2}{7.7 \text{ MeV}}$$

- FORTUNATELY WE DO NOT HAVE TO FOOL AROUND WITH e^2 IN COULOMBS, OR WHAT EVER

"FINE STRUCTURE CONSTANT" $\Rightarrow \frac{e^2}{\hbar c} = \frac{1}{137}$

$$e^2 = \frac{\hbar c}{137} \longleftarrow \hbar c = 197.3 \text{ MeV} \cdot \text{fm}$$

So

$$e^2 = \frac{197.3}{137} \text{ MeV} \cdot \text{fm} = 1.44 \text{ MeV} \cdot \text{fm}$$

$$R = \frac{2 \times 79}{7.7} \times 1.44 \frac{[\text{MeV}][\text{m}]}{[\text{MeV}]} \times 10^{-15}$$

$$R \sim 3 \times 10^{-14} \text{ m}$$

LARGE ANGLE
SCATTER



NUCLEAR RADIUS
 10^4 TIMES SMALLER
THAN BOHR RADIUS OF ATOM

MACROSCOPIC PHENOMENA REVEAL
THE MICROCOSM

QUANTUM FORCES & FEYMAN DIAGRAMS

- IN SIMPLE MODEL OF RUTHERFORD SCATTERING → USED CONCEPT OF FORCE.
- WHAT "IS" A FORCE → ANYTHING WHICH CHANGES MOMENTUM OF A PARTICLE
- FORCE = MASS X ACCELERATION = $m \cdot \frac{\Delta v}{\Delta t} = \frac{\Delta p}{\Delta t}$
- PHYSICAL MEASUREMENT ⇒ MOMENTUM CHANGE
- CAN HAVE DIFFERENT ABSTRACT IDEAS OF WHAT "CAUSES" MOMENTUM CHANGE
- CLASSICALLY → FIELDS CAUSED BY POTENTIALS

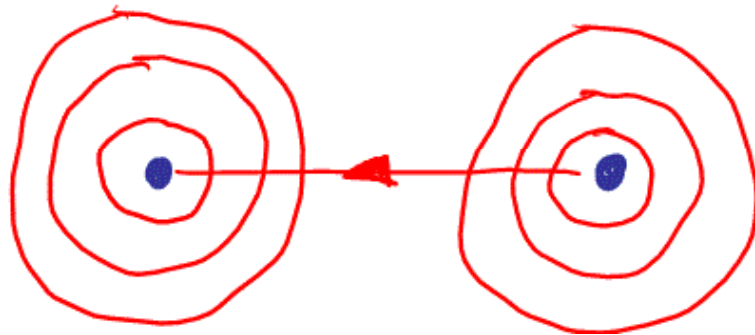

← ACTION AT A DISTANCE
NON QUANTUM CONCEPT.

- IN RELATIVISTIC QUANTUM MECHANICS
 - FORCES CAUSED BY EXCHANGE OF VIRTUAL PARTICLES (GAUGE BOSONS)
- HOW CAN THIS EXCHANGE BE A FORCE? — ANSWER ON 2 LEVELS
- SIMPLE — EXCHANGE CAUSES MOMENTUM CHANGE — BY DEFINITION A FORCE.

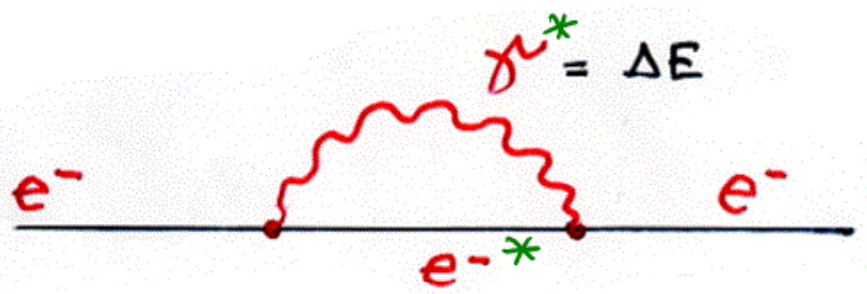

$\gamma^* \rightarrow$ VIRTUAL PARTICLE

$$E^2 = p^2 + m^*{}^2$$

↑
NOT PHYSICAL MASS

- ACCORDING TO HEISENBERG UNCERTAINTY
 - FREELY PROPAGATING ELECTRON CAN EMIT AND RE-ABSORB A PHOTON

• RE ABSORPTION HAS TO OCCUR WITHIN TIME

TIME VIRTUAL PARTICLE CAN EXIST \rightarrow

$$\Delta E \lesssim \hbar / \Delta t \quad \text{HEISENBERG}$$

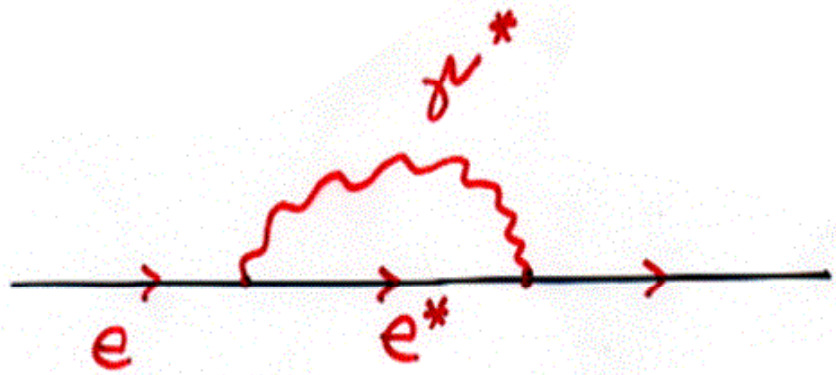

BETTER WAY TO THINK OF IT

γ CARRIES 4-MOMENTUM AWAY FROM ELECTRON

• IF $E_e^2 = p_e^2 c^2 + m_e^2 c^4 \rightarrow m_e^2 c^4 = E_e^2 - p_e^2 c^2$
 BEFORE THE EMISSION OF THE γ , THEN
 AFTER EMISSION

$$m_e^2 c^4 \neq E_e'^2 - p_e'^2 c^2 = m_e^{*2} c^4$$

• REAL γ $E_\gamma^2 - p_\gamma^2 c^2 = 0 \leftarrow$ MASSLESS

• VIRTUAL γ $E_\gamma'^2 - p_\gamma'^2 c^2 = m_\gamma^{*2} c^4 \leftarrow \gamma \neq e$ WILL HAVE
 NON PHYSICAL MASSES
 FOR $\Delta E \rightarrow$ "OFF MASS SHELL"

VIRTUAL PARTICLES



TRANSMIT FORCES

} TRANSFER
 MOMENTUM

INTERACTION → FORCE BETWEEN PARTICLES

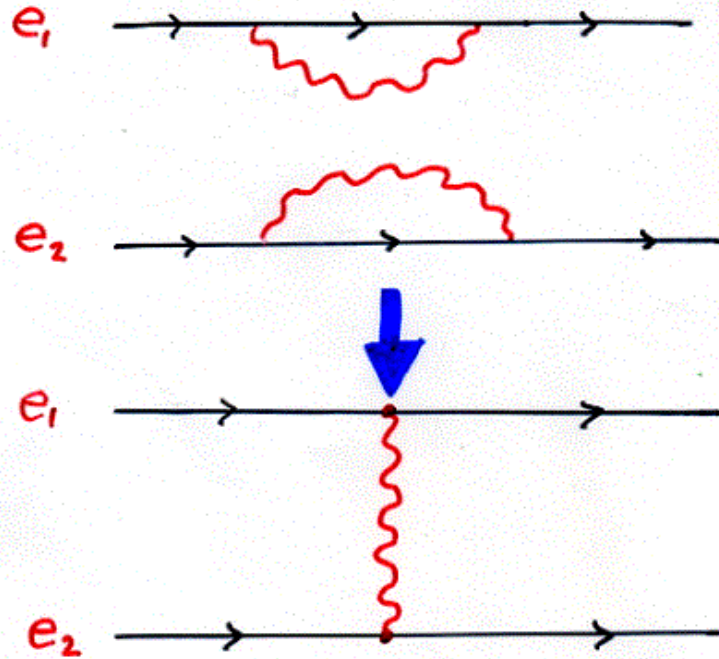

VIRTUAL PARTICLE
EMMISSION

↳ MOMENTUM
TRANSFER
BETWEEN
 e_1 & e_2

- ↳ MOMENTUM TRANSFER — BOTH ENERGY & MOMENTUM
- TWO ELECTRONS IN INITIAL & FINAL STATE ENSURE THAT ENERGY & MOMENTUM CONSERVED

PARTICLES IN INITIAL & FINAL STATE ARE

"ON MASS SHELL"

$$E^2 = p^2 + m^2$$

$$E^2 = p^2 c^2 + m^2 c^4$$

CLASSICAL \longleftrightarrow QUANTUM ANALOGY

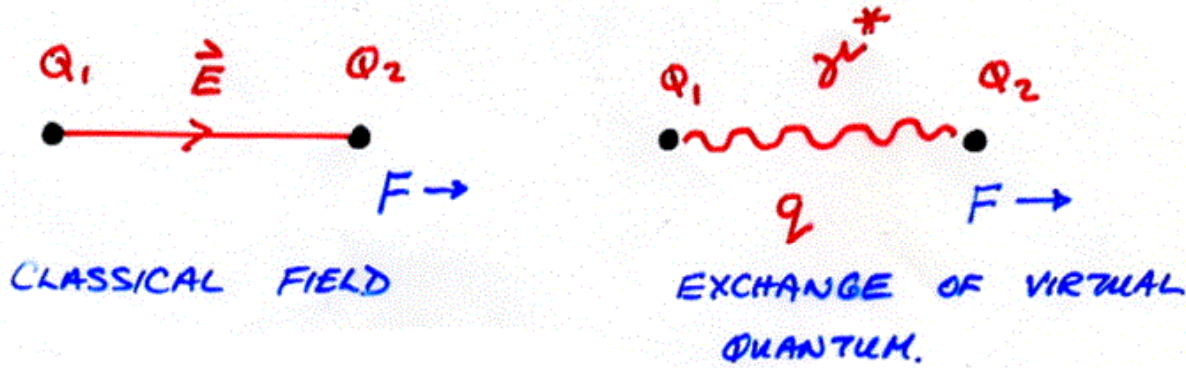

- $\Delta E \Delta t \lesssim \hbar$ PROPAGATION TIME OF VIRTUAL PARTICLE
- ASSUME VIRTUAL PARTICLE PROPAGATES AT VELOCITY OF LIGHT c

RANGE OF FORCE $R = c \cdot \Delta t \lesssim \frac{\hbar}{mc^2}$

FOR $m \rightarrow 0$; $R \rightarrow \infty$

FOR M LARGE ; R SMALL

$t \sim \Delta t \lesssim \frac{\hbar}{mc^2}$

$\sim \Delta E$ (green arrow pointing to \hbar)

MASS OF VIRTUAL PARTICLE (green arrow pointing to m)

COULOMB $m_\gamma = 0$

MASS OF EXCHANGED VIRTUAL PARTICLE DETERMINES RANGE OF FORCE

QUANTUM FIELD

- VIRTUAL PARTICLE
- ALL INTERACTIONS OCCUR AT POINTS IN SPACE-TIME
- UNFAMILIAR
→ BUT MAKES SENSE!

CLASSICAL FIELD

- SPOOKY ACTION AT A DISTANCE
- FAMILIAR?

F E Y M A N D I A G R A M S

- FEYNMAN DIAGRAM \rightarrow GRAPHICAL REPRESENTATIONS OF QUANTUM MECHANICAL AMPLITUDES

- PROBABILITY OF A PROCESS $\propto (\text{AMPLITUDE})^2$

- IF A PROCESS CAN OCCUR IN 2 DIFFERENT WAYS

$$\text{PROB} \propto (A_1 + A_2)(A_1 + A_2)$$

$A_1, A_2 \rightarrow$ COMPLEX NUMBERS

\therefore INTERFERENCE cf \rightarrow 2 SLIT EXPERIMENT WITH ELECTRONS

Q. M. AMPLITUDE \longleftrightarrow SPACE-TIME DIAGRAM

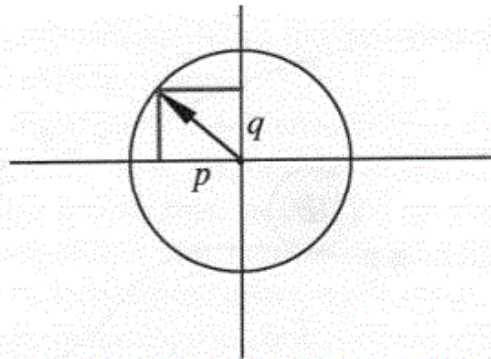

PARTICLE MOVING THRU SPACE-TIME NEEDS TO BE LABELED BY PHASE & AMPLITUDE

AMPLITUDE 1
PHASE 1

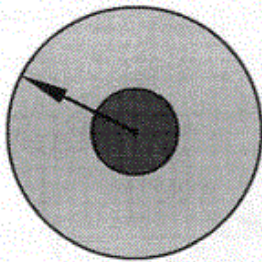

1



AMPLITUDE 2
PHASE 2

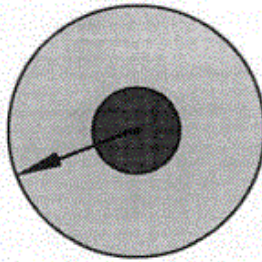

2

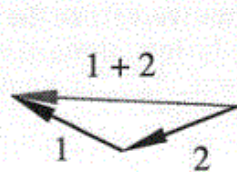

ADDITION OF AMPLITUDES

FREE PARTICLE

$$\psi = A e^{i(Et - px)/\hbar}$$

PHASE VARIES ALONG PATH

PLANE WAVE STATE

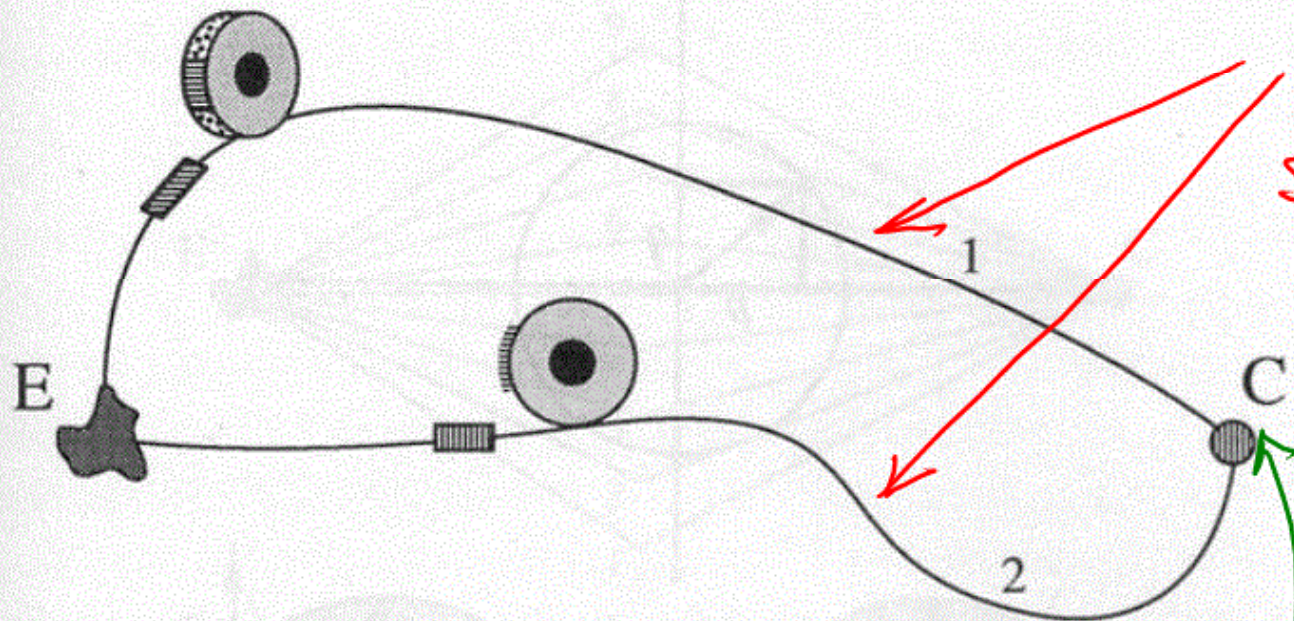

DIFFERENT
PATHS THRU
SPACE-TIME

↓
DIFFERENT
PHASES

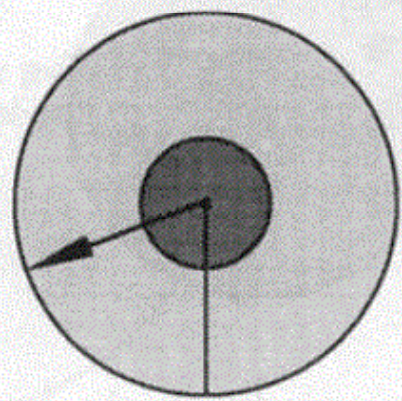
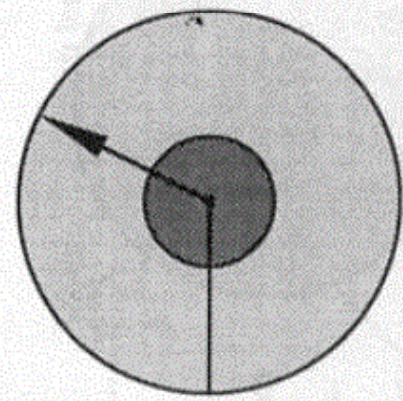

INTERFERENCE

FREE PARTICLE PROPAGATING $E \rightarrow C$

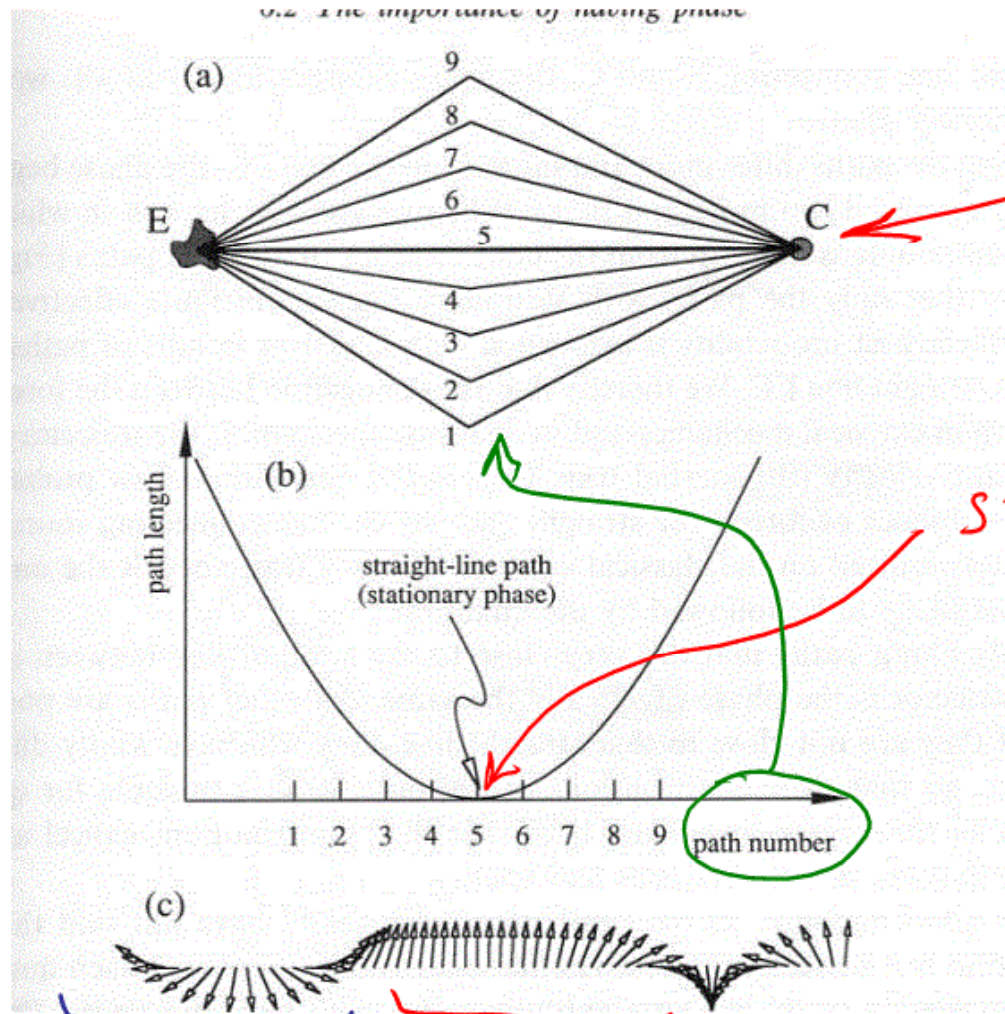

POSITIONS IN SPACE

STATIONARY PHASE

PHASES FAR FROM STRAIGHT LINE INTERFERE DESTRUCTIVELY

PHASES CLOSE TO STRAIGHT LINE INTERFERE CONSTRUCTIVELY

ADD AMPLITUDES FROM ALL POSSIBLE PATHS

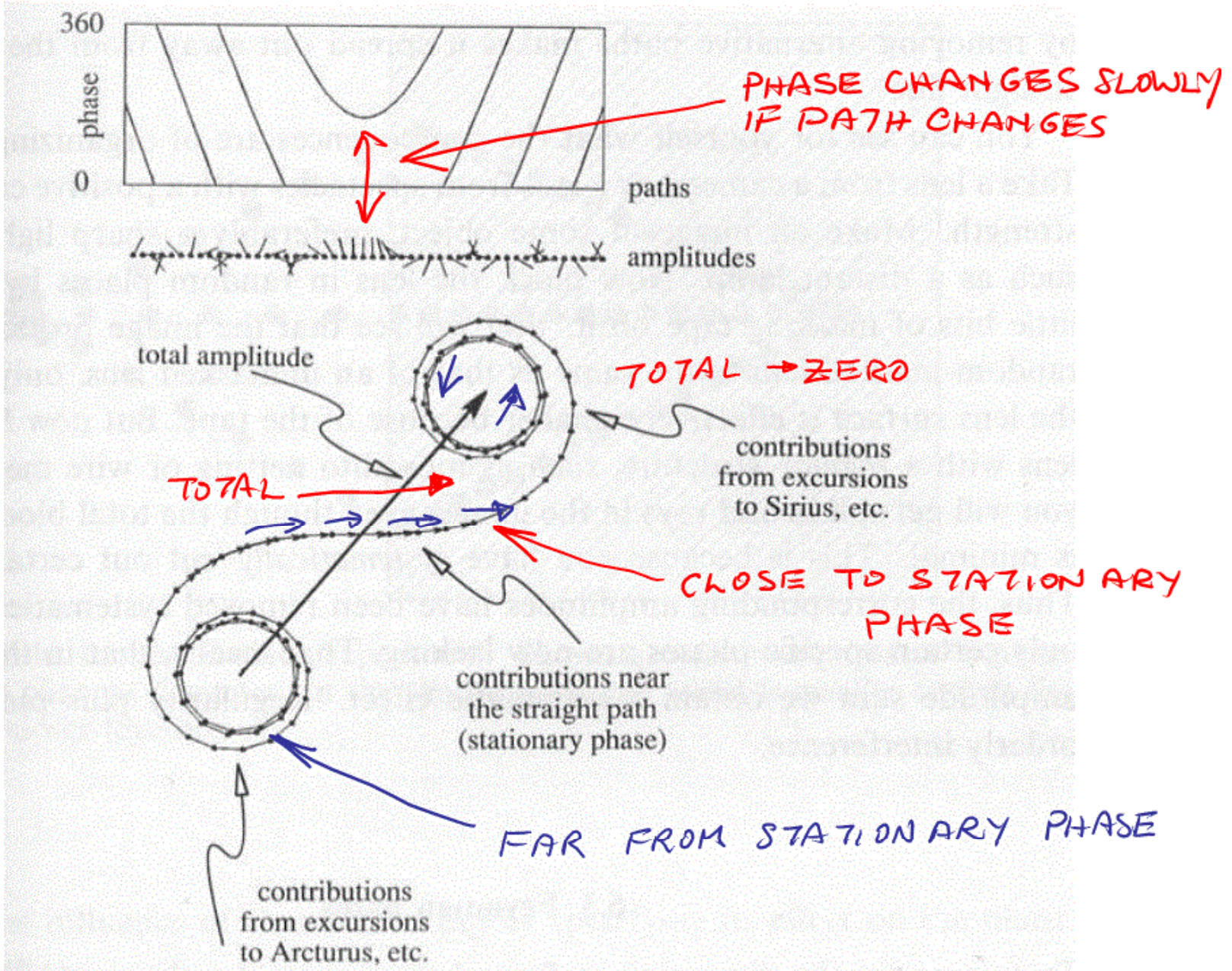

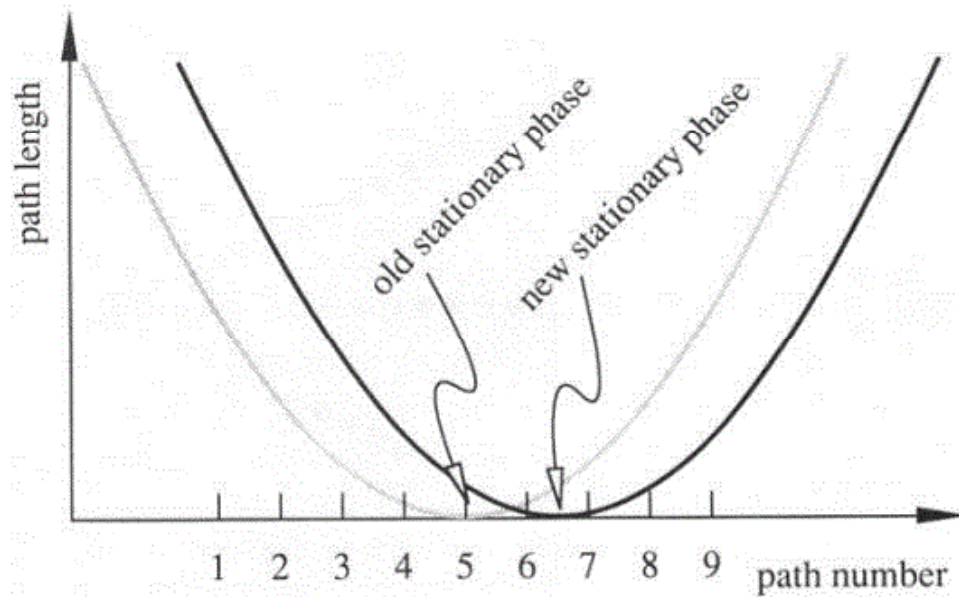

PARTICLE FOLLOWS
PATH OF LEAST
ACTION

$$\text{PHASE} = \frac{\text{ACTION}}{\hbar}$$

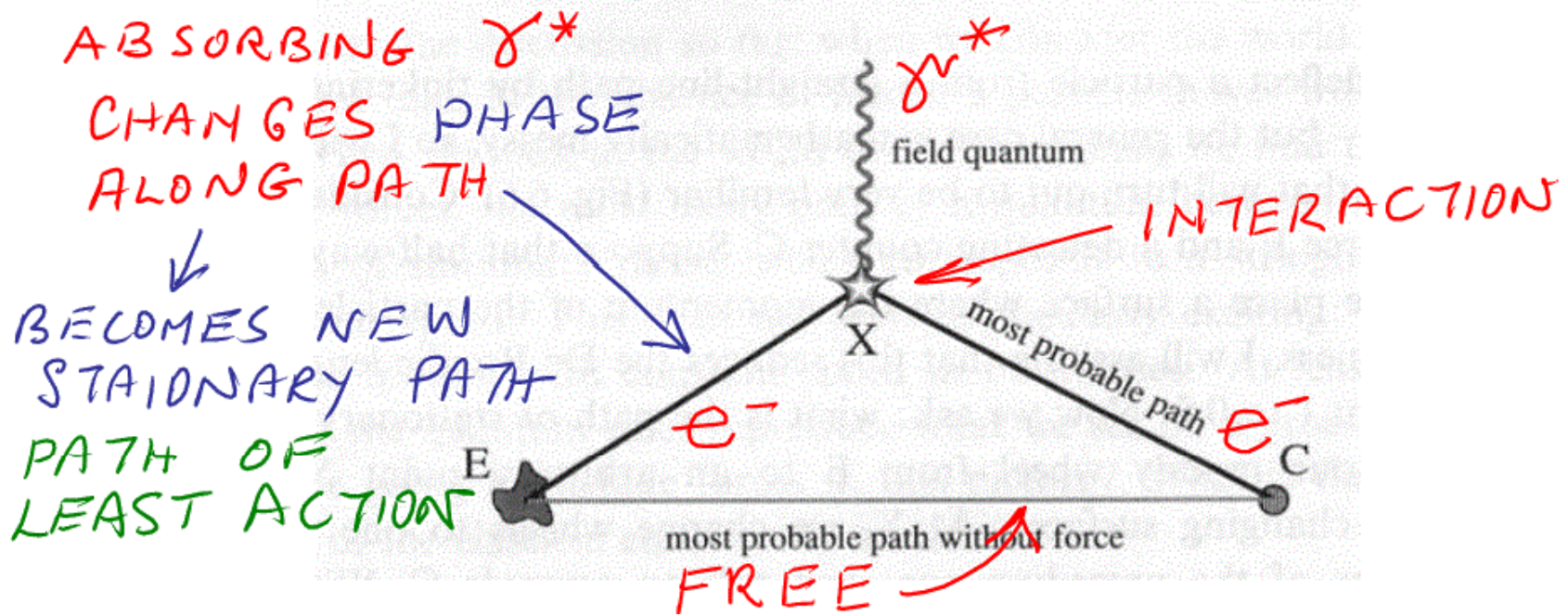

• IN QUANTUM MECHANICS

$$\delta(\text{PHASE}) = \frac{\delta(\text{ACTION ALONG PATH})}{\hbar}$$

$$\delta\phi \propto \delta S$$

\hbar \rightarrow \hbar IS QUANTUM OF ACTIONS

$$\delta\phi = F \delta S$$

PHASE CHANGE ALONG PATH \rightarrow $\delta\phi$

F \rightarrow CHANGE IN ACTION ALONG PATH

FIELD DENSITY \rightarrow F

$$P_{E \rightarrow C} = \left[\sum_{\text{PATH}} \delta\phi \right]^2$$

TOTAL PROBABILITY \rightarrow $P_{E \rightarrow C}$

SUM OVER ALL POSSIBLE PATHS \rightarrow \sum_{PATH}

SPACE - TIME
DIAGRAM

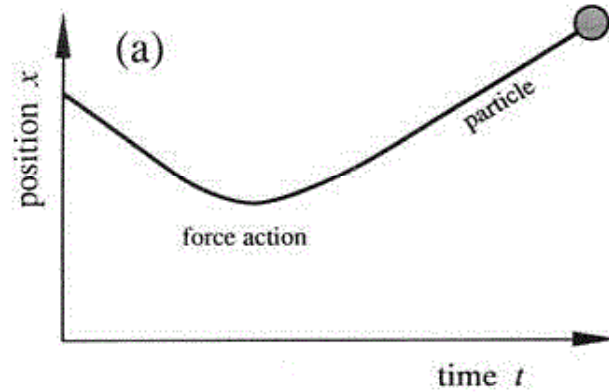

CLASSICAL

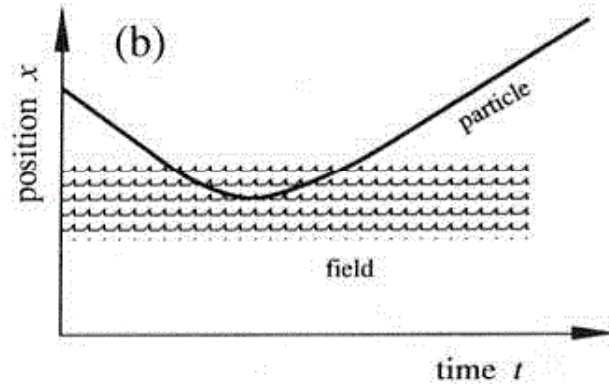

NON-RELATIVISTIC
QUANTUM MECHANICS

quantization



second
quantization



QUANTUM FIELD
THEORY

QUANTUM
AMPLITUDE

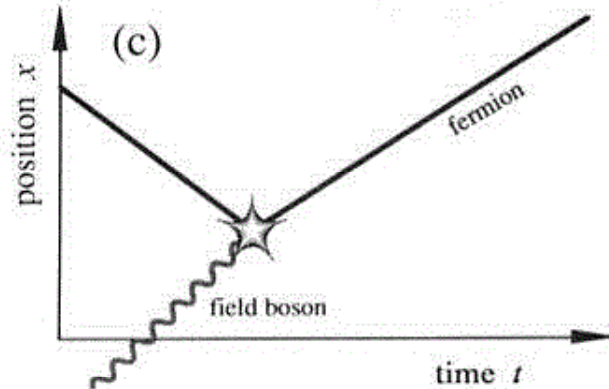

SPACE - TIME
DIAGRAM

=

QUANTUM
AMPLITUDE

QUANTUM FIELD THEORY

PHASE CHANGE = MOMENTUM CHANGE = SCATTERING OF PARTICLES

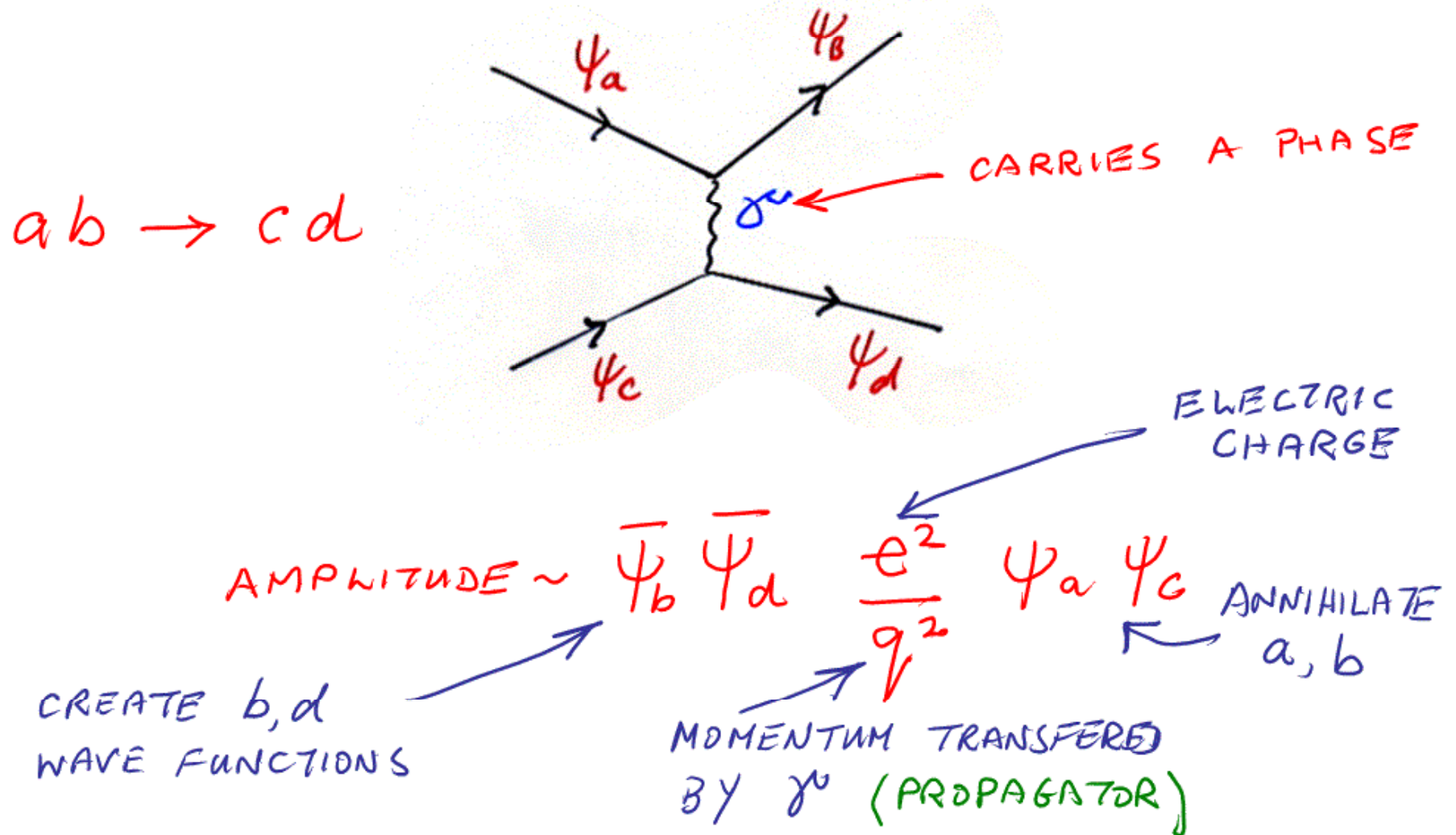

SCATTERING ANGLE & MOMENTUM TRANSFER

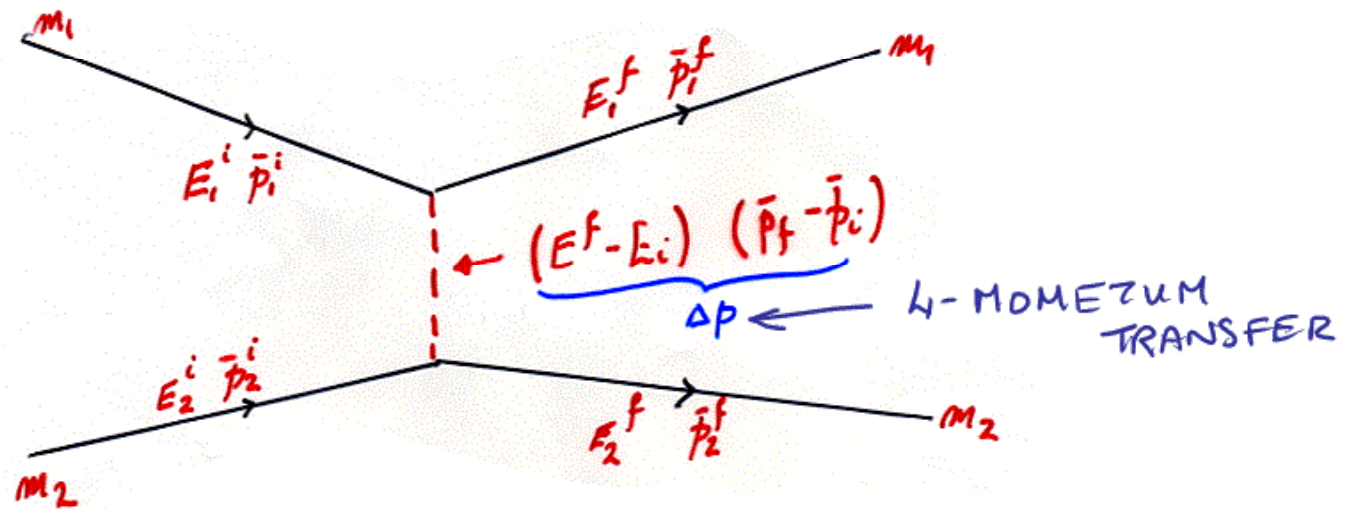

USE 4-VECTOR, PUT $c=1$

$$(\Delta p)^2 = (\vec{p}_1^i - \vec{p}_1^f)^2 = \vec{p}_1^{i^2} + \vec{p}_1^{f^2} - 2 \vec{p}_1^i \cdot \vec{p}_1^f \leftarrow \text{4-VECTORS}$$

$$\begin{aligned} p^2 &= (E, \vec{p})^2 \\ &= E^2 - \vec{p}^2 \\ &= m^2 \end{aligned}$$

$$\begin{aligned} & (E_1^i, \vec{p}_1^i) (E_1^f, \vec{p}_1^f) \\ &= 2E_1^f E_1^i - 2 \vec{p}_1^i \cdot \vec{p}_1^f \\ &= 2E_1^f E_1^i - 2 |\vec{p}_1^i| |\vec{p}_1^f| \cos \theta \end{aligned}$$

SCALAR

3VECTOR SCALAR PRODUCT

$$(\Delta p)^2 = m_i^2 + m_f^2 - 2E_i^i E_i^f + 2|\vec{p}_i^i| |\vec{p}_i^f| \cos\theta$$

IN LAB FRAME

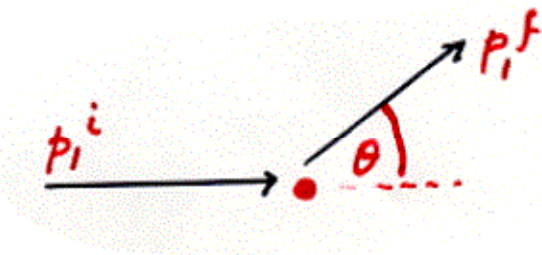

IF $E_i \gg m_i$

$$|\vec{p}_i|^2 = E_i^2 - m_i^2 \approx E_i^2$$

→ $(\Delta p)^2 = 2E_i^f E_i^i (\cos\theta - 1)$

TRUE IN
ANY FRAME
≡

4-MOMENTUM
SQUARED

$q^2 \sim \cos\theta$

$\Delta p = q$

4-MOMENTUM TRANSFER GIVEN BY
LABORATORY KINEMATICS

E^i INCOMING ENERGY

E^f OUTGOING ENERGY

θ SCATTERING ANGLE

SOME FEYNMAN DIAGRAMS

REMEMBER \rightarrow DIAGRAM REPRESENT Q. M. AMPLITUDE

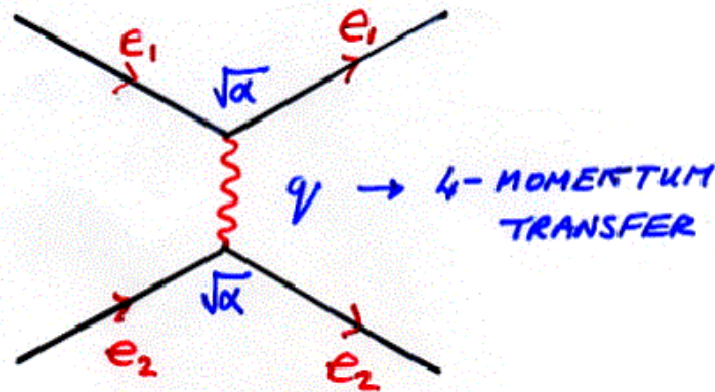

ELECTROMAGNETIC INTERACTION

PROBABILITY OF SCATTERING THROUGH $\theta \rightarrow P(\theta)$

$$P(\theta) = P(q^2) = |A(q^2)|^2$$

SIMPLE "FEYMAN RULE"

\uparrow QUANTUM MECHANICAL SCATTERING AMPLITUDE

$$A_{ee \rightarrow ee} \sim \frac{\sqrt{\alpha} \sqrt{\alpha}}{q^2} \sim \frac{e^2}{q^2}$$

$$\alpha = e^2 / \hbar c$$

$$P_{ee \rightarrow ee} \sim e^4 / q^4$$

PREDICTION \rightarrow



SIMPLE FEYMAN RULE

$$P \propto |A|^2 \sim e^4 / q^4$$

- SCATTERING DEPENDS ON $\sqrt{\alpha} \sim e$
- HARD TO SCATTER THROUGH LARGE ANGLES
 - HAVE TO TRANSFER A LOT OF 4-MOMENTUM
 - NEED "VERY VIRTUAL" PHOTON
- IN OUR SIMPLE MODEL OF RUTHERFORD SCATTERING

$$\Delta p^2 \sim q^2 \sim p^2 \theta^2$$



SO WE WOULD PREDICT THAT
THE PROBABILITY FOR SCATTERING THROUGH θ

$$P(\theta) \sim \frac{e^4}{p^4 \theta^4}$$

APPLY FEYMAN RULE TO OTHER SIMPLE E.M. PROCESSES

IN FREE SPACE
CANNOT HAVE



DOES NOT
CONSERVE
ENERGY &
MOMENTUM

- HOWEVER, A RECOILING NUCLEUS CAN PROVIDE MOMENTUM RECOIL TO

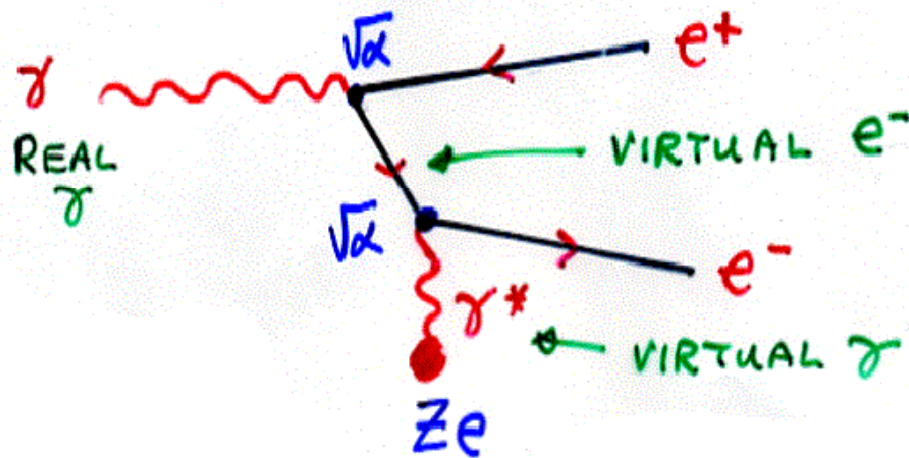

PROBABILITY $\sim |\sqrt{\alpha} \sqrt{\alpha} \cdot Z \sqrt{\alpha}|^2 \sim \alpha^3 Z^2$

$\sim e^6 Z^2$

THIS DEPENDENCE
ON Z^2 IS SEEN FOR
"PAIR PRODUCTION"

PERTURBATION EXPANSION

SAW \rightarrow IN Q.M. HAVE TO TAKE ACCOUNT OF ALL POSSIBLE WAYS A PROCESS CAN OCCUR

$$R_{\text{TOTAL}} = \begin{array}{c} \text{Diagram 1} \\ \alpha \\ 1/137 \\ 7 \times 10^{-3} \end{array} + \begin{array}{c} \text{Diagram 2} \\ \alpha^2 \\ (1/137)^2 \\ 5 \times 10^{-5} \end{array} + \begin{array}{c} \text{Diagram 3} \\ \alpha^3 \\ (1/137)^3 \\ 4 \times 10^{-7} \end{array} + \dots \infty$$

- HAVE TO JOIN INCOMING & OUT GOING LINES BY ALL POSSIBLE VIRTUAL LINES
- IN EM A GOOD APPROXIMATION IS JUST FIRST TERM
BORN APPROXIMATION



- ONLY WORKS BECAUSE $\alpha \ll 1$
- FOR STRONG FORCE $\alpha_s \gg 1$
"CORRECTIONS" DOMINATE \sum

ELECTRON / MUON MAGNETIC MOMENT

COUPLING TO
MAGNETIC
FIELD

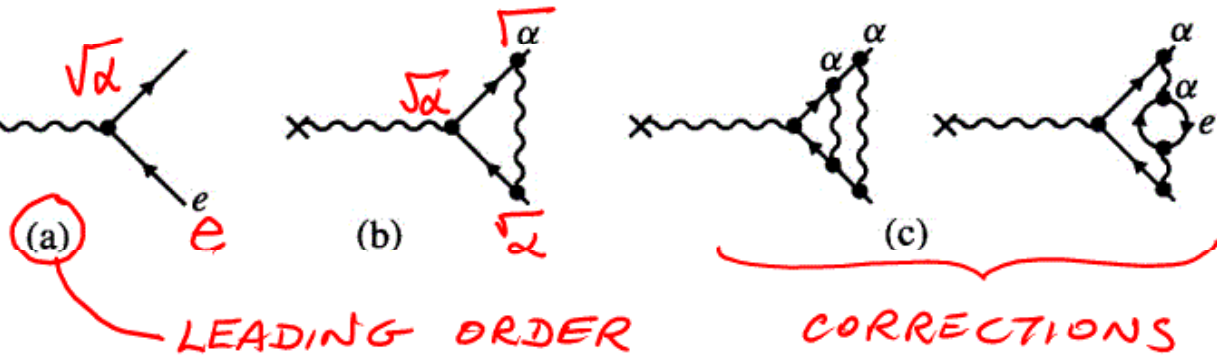

- HIGHER ORDER CORRECTIONS - SENSITIVE TEST OF THEORY
- MAGNETIC MOMENT OF CLASSICAL SPINNING PARTICLE

$$\vec{\mu} = \frac{e\hbar}{2mc} \cdot \vec{\sigma}$$

- FOR A DIRAC FERMION $\vec{\mu} = g \cdot \frac{e\hbar}{2mc} \cdot \vec{\sigma}$
 - ← SPIN
 - $g = 2$ ELECTRONS
 - $g = 1$ CLASSICAL

$$\vec{\mu} = g \left(1 + \frac{\alpha}{2\pi}\right) \frac{e\hbar}{2mc} \vec{\sigma}$$

$$g \Rightarrow 2 \left(1 + \frac{\alpha}{2\pi}\right)$$

$$; \frac{g-2}{2}$$

"ANOMALOUS" MAGNETIC
MOMENT IN ADDITION
TO DIRAC

SMALL CLARIFICATION

FOR ELECTRON $\bar{\mu}_e = g \cdot \frac{e \cdot \hbar}{2m_e c} \bar{\sigma}$

g - FACTOR
 = 1 CLASSICALLY
 = 2 FOR ELECTRON

$\bar{\sigma}$ — ANGLEULAR MOMENTUM

$\frac{e \cdot \hbar}{2m_e c}$ — μ_B

$$\bar{\mu}_e = \underbrace{2(1 + a_e)}_g \mu_B \bar{\sigma}$$

$$g = 2 + 2a_e$$

$$\frac{g-2}{2} = a_e = \frac{\alpha}{2\pi} + \dots$$

PRECISION OF M.M. PERTURBATION EXPANSION

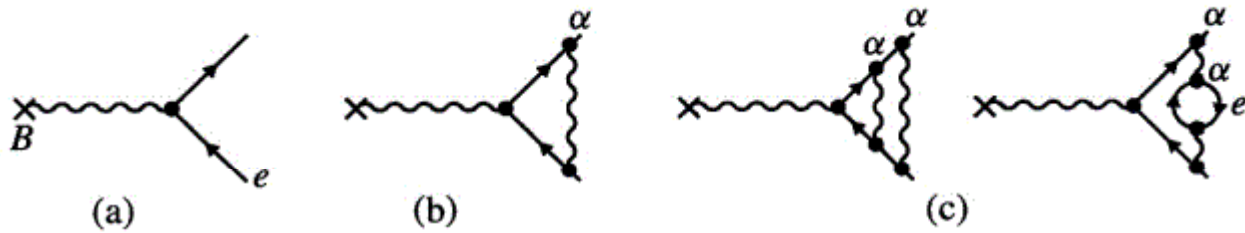

$$\begin{aligned}
 \frac{g}{2} &= 1 + \frac{\alpha}{2\pi} - 0.328478966 \left(\frac{\alpha}{\pi}\right)^2 \\
 &+ 1.1765 \left(\frac{\alpha}{\pi}\right)^3 - 0.8 \left(\frac{\alpha}{\pi}\right)^4
 \end{aligned}$$

$$= 1.001159652307 \quad (110) \quad \text{THEORY}$$

$$1.001159652193 \quad (10) \quad \text{EXPERIMENT}$$

CAN MAKE ARBITRARILY ACCURATE PREDICTION

$$a_e = \frac{g_{-2}}{2} =$$

$$\frac{\alpha}{2\pi}$$



$$-0.328478966 \left(\frac{\alpha}{\pi}\right)^2$$



$$+ (1.1765) \left(\frac{\alpha}{\pi}\right)^3$$

72 DIAGRAMS

$$- (0.8) \left(\frac{\alpha}{\pi}\right)^4$$

891 DIAGRAMS

$$a_e^{\text{TH}} = 11596522044 \times 10^{-13}$$

$$a_e^{\text{EXP}} = 11596521884 \times 10^{-13}$$



72 $\mathcal{O}(\alpha^3)$

DIAGRAMS

Fig. 8.2 The Feynman graphs which have to be evaluated in computing the α^3 corrections to the lepton magnetic moments (after Lautrup *et al.* 1972).

CORRECTIONS BEYOND $e \nleftrightarrow \gamma$

- CONTRIBUTION TO e MAGNETIC MOMENT FROM $\mu, \tau, \text{HADRONS}, \text{WEAK BOSONS}.$

$$\delta(a_e)_\mu = \left(\frac{\alpha}{\pi}\right)^2 \frac{1}{45} \left(\frac{m_e}{m_\mu}\right)^2$$

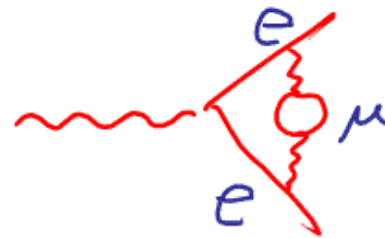

2.8×10^{-13}

$\delta(a_e)_\tau \quad 0.1 \times 10^{-13}$

$\delta(a_e)_{HAD}$

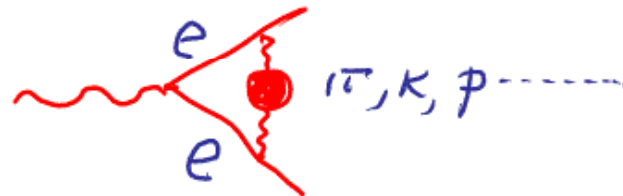

16×10^{-13}

$\delta(a_e)_{WEAK}$

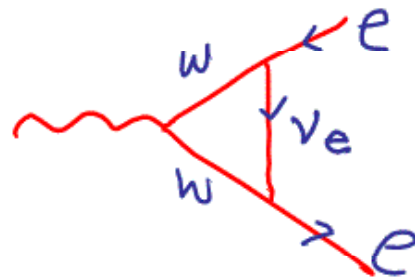

0.5×10^{-13}

PLUS ANYTHING ELSE WHICH EXISTS

The standard model's greatest triumph

Gerald Gabrielse

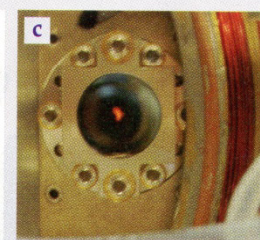
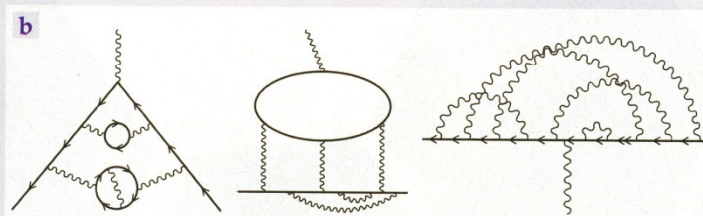

HANÇOIS BIRABEN

d Predicted: $\mu/\mu_B = -1.001\,159\,652\,181\,78\ (77)$
 Measured: $\mu/\mu_B = -1.001\,159\,652\,180\,73\ (28)$

Unprecedented confrontation of theory and experiment. **(a)** Our Penning trap shown here suspended a single electron for the months it took to measure its magnetic moment μ —the

most precisely measured property of an elementary particle. **(b)** The magnetic moment is also the quantity most precisely predicted by the standard model of particle physics. The prediction requires the calculation of nearly 14 000 integrals. These Feynman diagrams represent three of those. **(c)** Fluorescing rubidium atoms are used to measure the fine-structure constant α , which gives the strength of the electromagnetic interaction. The measured α and the standard-model calculation are the essential inputs for the precise prediction. **(d)** The predicted and measured values of μ agree to an astounding part per trillion. Both values shown here are divided by the Bohr magneton μ_B defined in the text. Parentheses denote uncertainties in the rightmost two digits.

The C_n are calculated by evaluating Fermi to B , which must then be measured to extract μ . Fortunately, the cyclotron frequency, $\omega_c = eB/m$ for an electron with charge $-e$ and mass m , is also proportional to B , so it can be used as an internal magnetometer. The electron is kept cold—with a temperature less than 0.1 degree above absolute zero—to keep the cyclotron motion in its quantum ground state. As with spin flips, a measurable one-quantum excitation of the cyclotron motion, which increases the energy by $\hbar\omega_c$, requires an appropriate driving force. Excitations take place more frequently as the drive frequency approaches ω_c .

Eliminating B from $\hbar\omega_s = -2\mu B$ and $\omega_c = eB/m$ gives the magnetic moment as a ratio of the two measurable frequencies, $\mu/\mu_B = -\omega_s/\omega_c$. The Bohr magneton $\mu_B = eh/(2m)$ is the magnetic moment for circular electron motion with angular momentum \hbar . The magnetic moment μ is negative—

(Hadrons are heavy particles whose internal structure would need to be known here if the correction weren't so small.) The standard-model weak-interaction contribution to the electron moment, a_{weak} , is smaller than the measurement precision.

Quantum electrodynamics gives a_{QED} as a power series in the fine-structure constant, $\alpha \approx e^2/(4\pi\epsilon_0\hbar c) \approx 1/137$, which is a measure of the strength of the electromagnetic interaction in the low-energy limit. Specifically,

$$a_{\text{QED}}(\alpha) = C_2 \left(\frac{\alpha}{\pi}\right) + C_4 \left(\frac{\alpha}{\pi}\right)^2 + C_6 \left(\frac{\alpha}{\pi}\right)^3 + C_8 \left(\frac{\alpha}{\pi}\right)^4 + C_{10} \left(\frac{\alpha}{\pi}\right)^5 + \dots$$

Each of the five displayed terms is much smaller than the previous one, but all are needed to achieve the measurement precision of the magnetic moment.

2.4 Feynman diagrams

35 Q.E.D.

IN AMPLITUDE

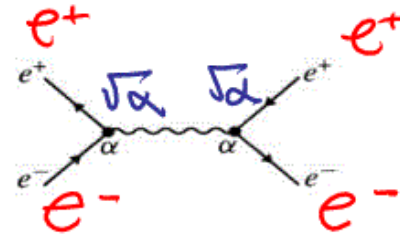
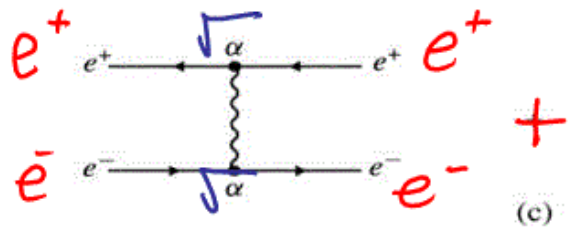
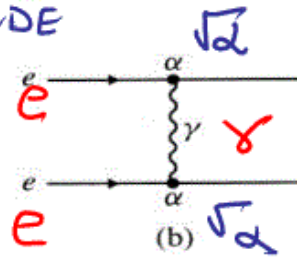
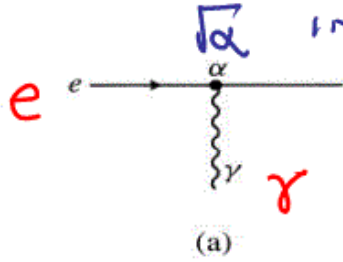

TWO WAYS IT CAN HAPPEN
 $A = (A_1 + A_2)$

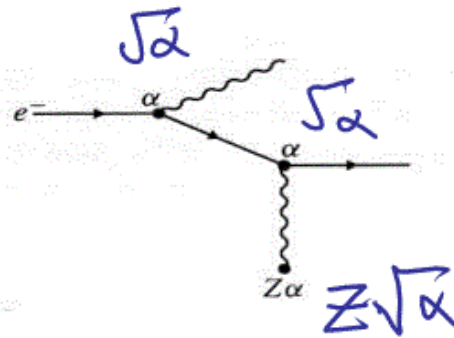
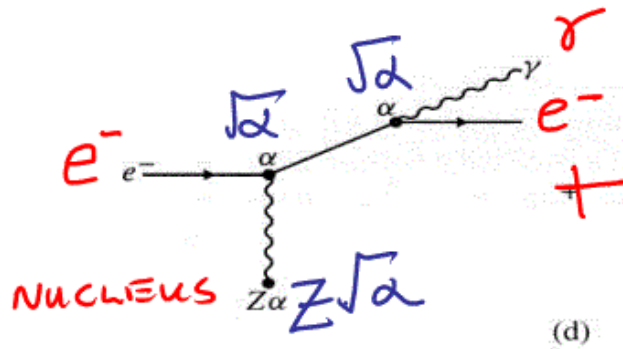

BREMSTRAHLUNG

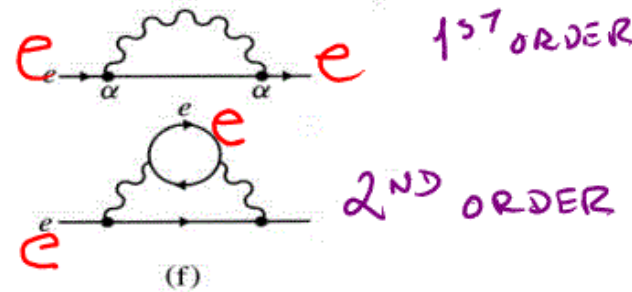
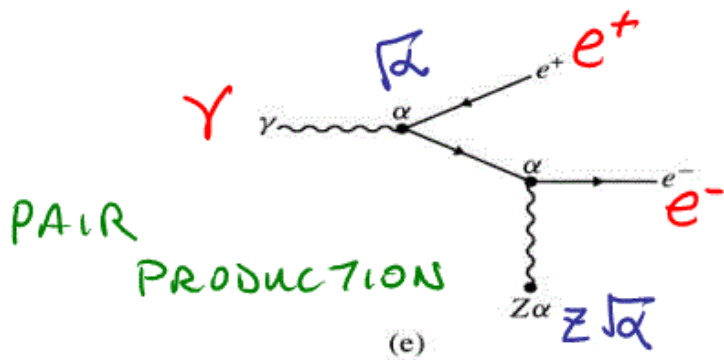

CORRECTIONS TO BARE ELECTRON MASS

WEAK INTERACTIONS

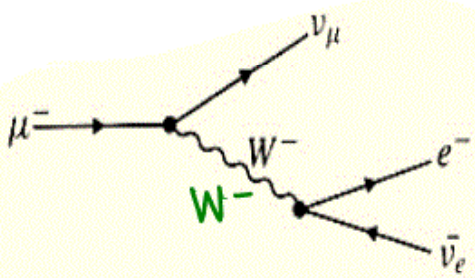

(b) $\mu^- \rightarrow \nu_\mu \bar{\nu}_e e^-$

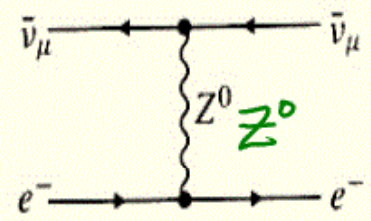

$\bar{\nu}_\mu e^- \rightarrow \bar{\nu}_\mu e^-$

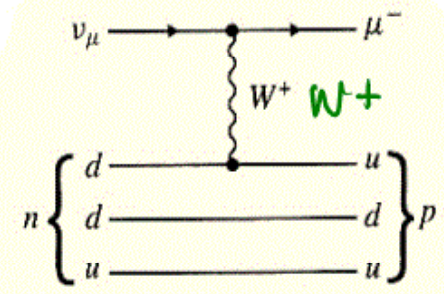

$\nu_\mu n \rightarrow \mu^- p$

(a)

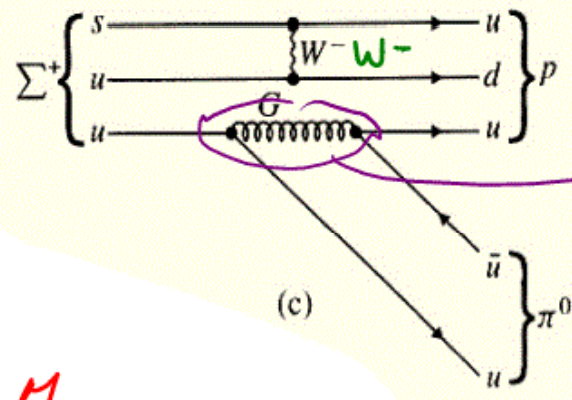

$\Sigma^+ \rightarrow p \pi^0$

STRONG INTERACTION

(c)

CLOSELY RELATED TO E.M.

EM
 γ^0
 $M=0$

WEAK
 W^+
 Z^0
 W^-
 $M \approx 90 \text{ GeV}$

$\frac{e^2}{q^2} \rightarrow \frac{g^2}{q^2 - M_{W,Z}^2}$ ← MASS OF EXCHANGE

$g \approx e$

IF $g = e$ WHY IS THE WEAK INTERACTION WEAK?

EM $\frac{e^2}{q^2} \rightarrow \frac{g^2}{q^2 - M_{W,Z}^2}$ WEAK

FOR $q^2 \ll M_W^2 \rightarrow \frac{g^2}{M_W^2}$

THIS LOOKS LIKE

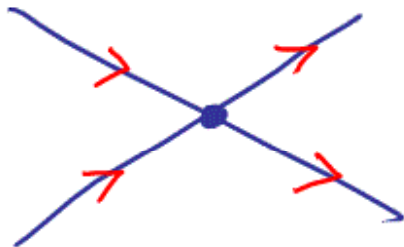

POINT LIKE
NO q^2 DEP

4-FERMION
INTERACTION

$G \equiv \frac{g^2}{M^2} \approx 10^{-15} \text{ GeV}^{-2}$



REASON FOR WEAKNESS

• NOT WEAK WHEN $q^2 \sim M_{W,Z}^2$

STRONG FORCE \equiv COLOR FORCE = QUANTUM CHROMODYNAMICS

QED

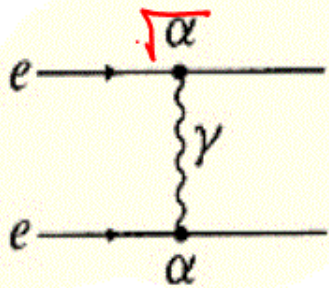

QCD

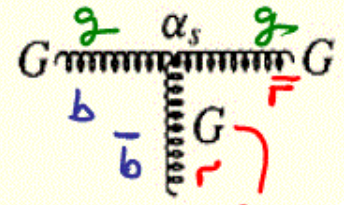
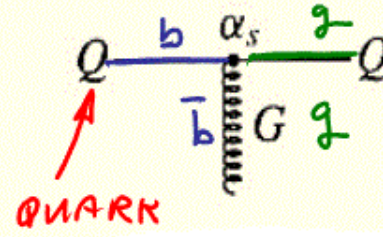
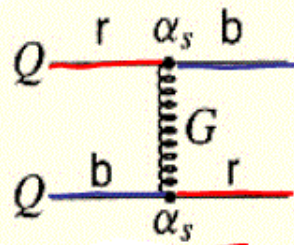

$\sqrt{\alpha_s} \leftarrow !$

COLOURED QUARKS

GLUON
BICOLOURED
GLUONS

• CHARGE $e \longrightarrow$ CHARGE RED, BLUE, GREEN

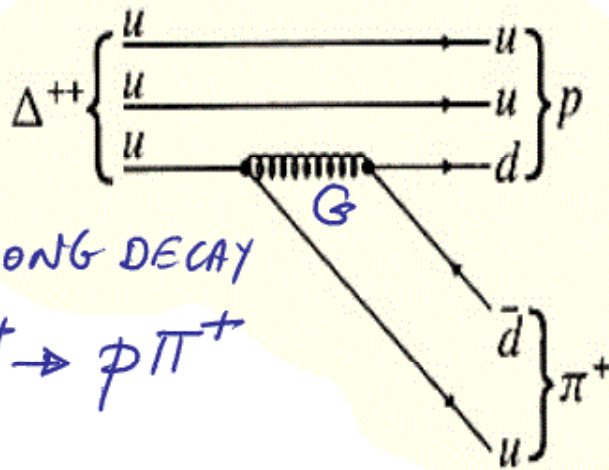

STRONG DECAY

$\Delta^{++} \rightarrow p \pi^+$

• GLUONS CARRY COLOR



• GLUONS CHANGE COLOR OF QUARKS

• γ DOES NOT CARRY ELECTRIC CHARGE



DOES NOT EXIST

WHY IS THE STRONG FORCE STRONG?

QCD IS "ASYMPTOTICALLY FREE"

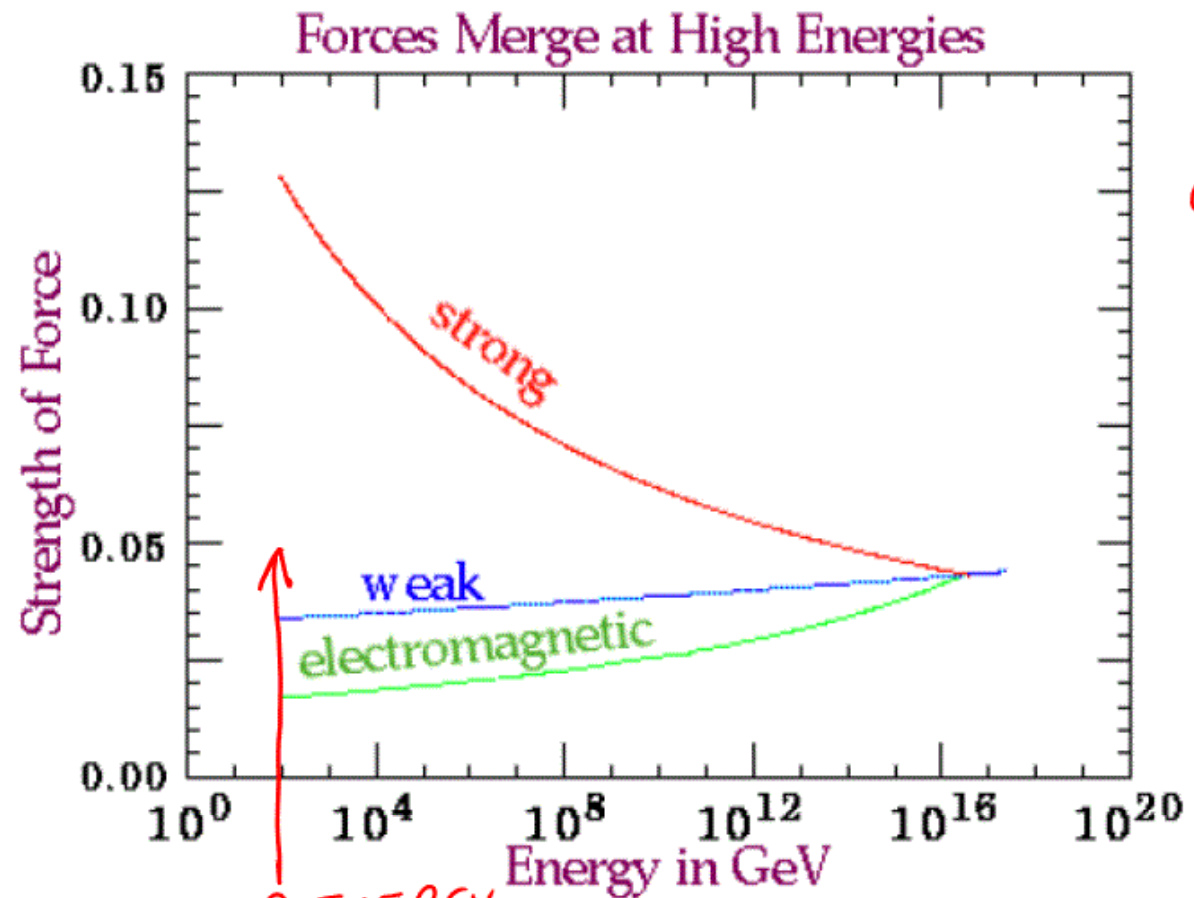

$$\alpha_s(q^2) = \frac{1}{B \ln q^2/\Lambda}$$

SCALE OF STRONG FORCE

NOTE THAT STRENGTH OF ALL FORCES VARY WITH ENERGY SCALE

OUR ENERGY SCALE

GAUGE BOSONS → 1
 3
 8
 $W^\pm Z^0$ GLUONS

GAUGE SYMMETRY GROUP → $U(1) \times SU(2) \times SU(3)$

Table 2.2. *Fundamental interactions* ($Mc^2 = 1 \text{ GeV}$)

	Gravitational	Electromagnetic	Weak	Strong
field boson	graviton	photon	W^\pm, Z	gluon
spin-parity	2^+	1^-	$1^-, 1^+$	1^-
mass, GeV	0	0	$M_W = 80.2$ $M_Z = 91.2$	0
range, m	∞	∞	10^{-18}	$\leq 10^{-15}$
source	mass	electric charge	'weak charge'	'colour charge'
coupling constant	$\frac{G_N M^2}{4\pi\hbar c}$ $= 5 \times 10^{-40}$	$\alpha = \frac{e^2}{4\pi\hbar c}$ $= \frac{1}{137}$	$\frac{G(Mc^2)^2}{(\hbar c)^3}$ $= 1.17 \times 10^{-5}$	$\alpha_s \leq 1$
typical cross-section, m^2		10^{-33}	10^{-39}	10^{-30}
typical lifetime, s		10^{-20}	10^{-10}	10^{-23}